

ROBAM

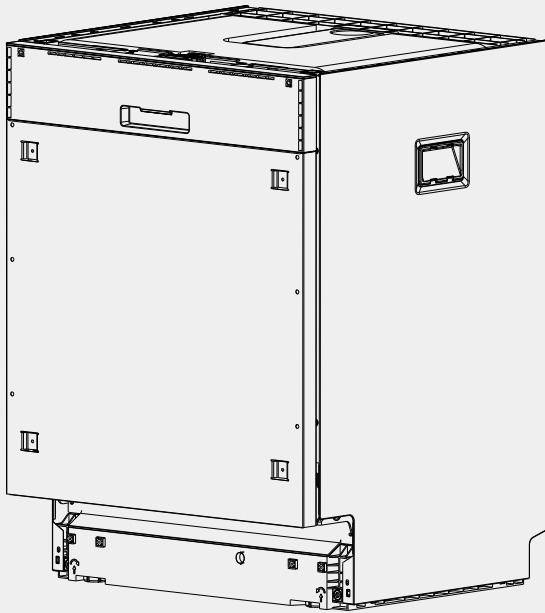

User Manual

Before operating this unit, please read the user manual completely and keep it. If the manual is lost, you can send e-mail to overseas@robam.com, request for an electronic manual.

W653
Dishwasher

CONTENTS



Safety Precaution	1
Product Description	3
User Manual.....	5
Installation	11
Maintenance	17
Circuit Diagram	18
Troubleshooting of General faults	19

Safety Precaution









In order to avoid harm or property damage to the users or other person, the following distinction and marks are stipulated.

They are important safety precaution, please comply strictly based on the full understanding.

Subject to Harmful or Destruct Degree









 Danger	If ignore this sign and operate product improperly, it's highly possible to cause danger, serious injury or fire.
 Warning	If ignore this sign and operate product improperly, it's possible to cause danger, serious injury or fire.
 Notice	If ignore this sign and operate product improperly, it's possible to cause injury or loss.

Notice and Prohibit Mark

















 Prohibit	 Prohibit Flame	 Prohibit Touch	 Prohibit Disassembly	 Strict Execution	 Necessary Earthed	 Caution Electric Shock	 Caution Scald
--	--	--	--	--	--	--	---







Please use this product according to manual strictly, or ROBAM shall not take any responsible caused by improper operation.

 Danger	
 Strict Execution When pulling out the plug on the socket, you must pull it out by holding the end of the plug by hand, please do not pull the plug with the power cord in your hand, otherwise it is easy to happen electric shock, short circuit, fire and other dangers.	 Prohibit Please do not use loose or poor contact with the power outlet, otherwise it will easily lead to electric shock, short circuit, fire and other dangers.
 Caution Scald Do not open the dishwasher door during the operation of the dishwasher, especially during the heating stage, if you open it, you may be burned by steam or splashed by hot water. Dishwashers are equipped with a safety system that will stop the dishwasher as soon as the door is opened.	 Strict Execution Detergents contain harsh and abrasive substances. The substance can have a corrosive effect on the eyes, mouth and throat. Swallowing may cause extreme. Its serious consequences. Avoid contact with mouth and throat.
 Strict Execution Do not change or attempt to change the characteristics of the product as this may be dangerous for you.	 Strict Execution Keep the whole machine away from heat sources, gas and alcohol and other flammable items.
 Prohibit Do not use other chemical solutions in the dishwasher, they may cause an explosion.	 Prohibit Do not put anything in the dishwasher that could cause Dangerous items.

Warning

 Strict Execution If the supply cord is damaged, it must be replaced by the manufacturer, its service agent or similarly qualified persons in order to avoid a hazard.	 Necessary Earthed Use a 10A or higher outlet alone, do not use the same electrical outlet with several appliances at the same time, and make sure the outlet is safely and effectively grounded.
 Strict Execution When using this product, the water in the dishwasher is not suitable for drinking; therefore, keep children away from the dishwasher when the door is open.	 Strict Execution Do not damage the power cord. Do not bend, stretch, twist, or knot the power cord when using it. Do not use heavy objects to buckle and pinch the power cord.
 Strict Execution If the dishwasher breaks down, do not try to do it yourself Restoration. Repairs by non-professionals may Causes control failure or more serious damage.	 Strict Execution This product is designed for daily household use. Do not use for industrial, commercial or other purposes.
 Strict Execution Before performing any maintenance operations on this product, disconnect the power and turn off the water supply.	 Strict Execution Avoid placing the dishwasher next to cookware or heating equipment to prevent any heat damage.
 Strict Execution Do not lean or sit on the dishwasher door when it is open; close the door as you go. Doors should not be left in the open position since this could present or tripping hazard.	 Prohibit This appliance is not intended for use by persons(including children)with reduced physical, sensory or mental capabilities, or lack of experience and knowledge, unless they have been given supervision or instruction concerning use of the appliance by a person responsible for their safety. Children should be supervised to ensure that they do not play with the appliance.
 Strict Execution Dishwasher specific washing products must be used.	
 Strict Execution If any replacement parts are needed, the original parts must be used.	
 Strict Execution When the dishwasher is not used for a long time or after use, disconnect the power and turn off the water supply.	 Strict Execution WARNING: Knives and other utensils with sharp points must be loaded in the basket with their points down or placed in a horizontal position.
 Strict Execution If you remove wash items from the dishwasher before the end of the wash cycle, be sure to rinse again to remove any residual detergent.	 Strict Execution Place washing products such as special detergents out of the reach of children.

Notice

 Strict Execution Dishwasher factory need to be leak detection, the machine with a small amount of residual water inside is a normal phenomenon.	 Strict Execution Always make sure that the electrical connection information on the product nameplate matches the specifications of your power supply.
 Strict Execution If the dishwasher fails to function for reasons not mentioned in the manual, please disconnect the power supply and contact the after-sales service.	 Prohibit Please do not throw water on the body, it may lead to fire and electric shock.
 Strict Execution Please install the product in a place where it is easy to reach the outlet or power switch. The power cord must be easily plugged in to ensure that the appliance can be disconnected from the power supply at any time after installation.	

Product Description

Dear User:

Thank you for purchasing a Robam dishwasher. In order to enable you to use this product correctly, please read this manual in detail before using and keep it properly for future reference.

*The pictures in this manual are schematics for reference only, if the pictures do not match the real thing, the real thing shall prevail. The appearance structure of our products is constantly being improved, and changes to the content caused by product improvements will be made without notice.

Important Information

Package of Dishwasher

Please dispose of these packaging materials in an environmentally friendly manner to maintain a good environment. Do not allow children to play with plastic film, cardboard boxes and other packaging materials, which may cause choking accidents.

Technical Data

Model	W653	Product Dimension (W×H×D)	(598×818×555)mm
Rated Voltage	220V-240V	Energy Consumption Level	D
Rated Frequency	50Hz	Work Cycle Water Consumption	8.9L
Rated Power	1720W-2030W	Work Cycle Power Consumption	0.85kW·h/cycle
Water Pressure	0.1MPa-1.0MPa	Capacity	14 sets
Net Weight	36kg	Noise Level	46dB

Note: The performance indicators in the table above are at the recommended rinse aid d4 grade, according to EU standards, at "🍃"(Eco mode) test data under the function program.

ROBAM | Dishwasher

Product Structure

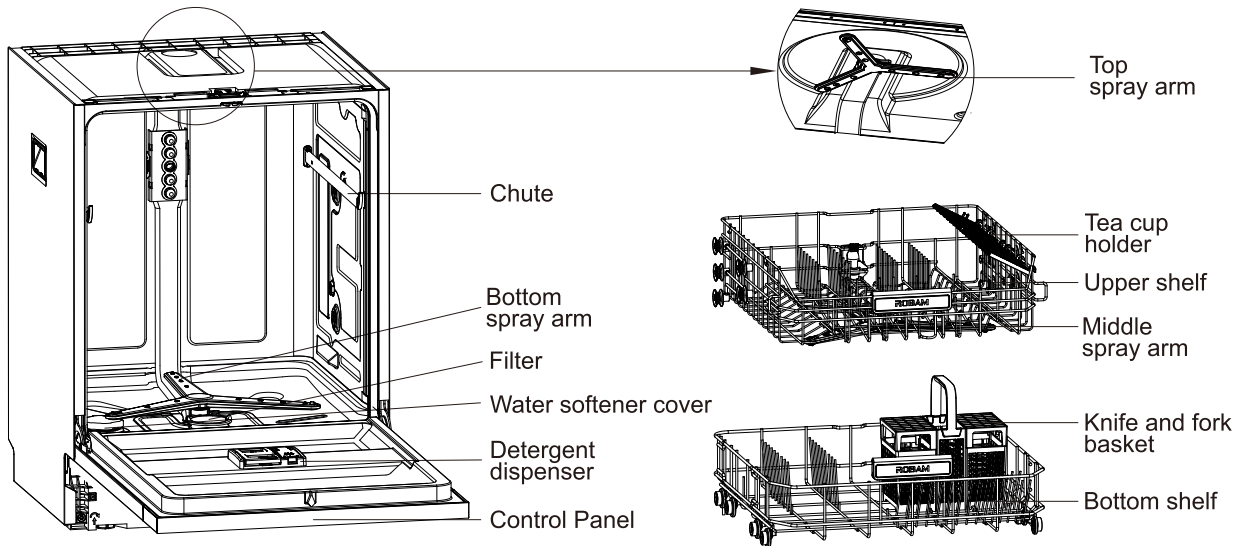

Packing List

No.	Name	Quantity
1	Dishwasher	1
2	User manual	1
3	Installation package	1

Control Panel Introduction

Control Panel

Main Program	Intensive	Eco	Quick	AUTO Auto	Glass	Quiet
Additional Features	1/2 Half Load	Anti-Bac	Dry	Delay		
Display area	Salt deficiency indication	Lack of brightener indication	Water shortage indication	Temperature indication		

● Main program description: See the main program description table on page 11 for details.

User Manual

Use of Water Softening Systems

In order to achieve the ideal cleaning effect, dishwashers need to use soft water with low hardness, due to the different water quality in different places, this product comes with a water softening device, when the lack of salt indicator "S" light up, please add special salt promptly.

■ Loaded with special salt

- a. Remove the bottom shelf and open the water softener cover by turning counterclockwise (Fig. a, Fig. b);
- b. Add approximately 1 kg of water to the water softener of the dishwasher for the first use only (Fig. c);
- c. Use the salt addition funnel to add dishwasher-safe salt to the water softener (Figure d). To accelerate the dissolution of salt in water, use a spoon to stir;
- d. After the salt is added, tighten the water softener cover.

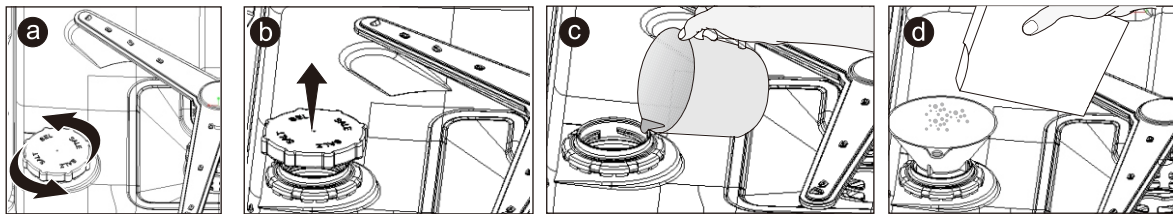

Attention

- Immediately after the special salt is added, a "Quick" program is run to remove any residual salt from the chamber.
- In water softening systems, always use dishwasher-safe salt. The use of salt that is not completely dissolved in water, such as refined table salt or rock salt, is strictly prohibited.
- Up to 1kg of special salt can be added to the water softener.
- Specialized salt may take longer to dissolve in water. The salt deficiency indicator will remain on for a period of time after the dishwasher has been refilled with special salt.
- Open the water softener cover only when adding special salt.

Use of Detergent Dispenser

■ Introduction of detergent

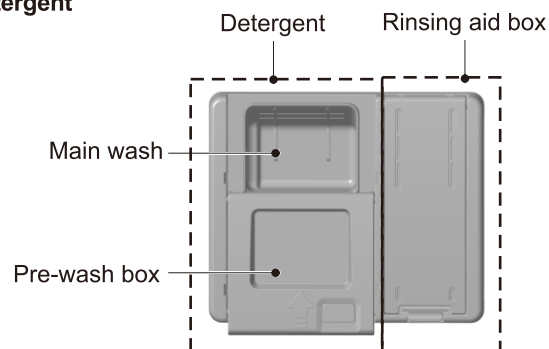

■ Adding detergent

Add detergent to the detergent dispenser as shown in the figure below:

1. Press the locking pin in the direction of the arrow (Fig. a) to open the detergent compartment lid;
 2. Add the recommended amount of powder or lump detergent to the detergent cartridge (Figure b);
- Note:
- Inside the detergent dispenser, there are volume markings for adding detergent by referring to the main program instructions table on page 11;
 - Prewash detergent is placed in the prewash box, refer to the main program instructions table on page 11 for dosage.
3. Push the detergent lid in the direction of the arrow (Fig. c) and the lid will "click" to indicate that it is closed (Fig. d).

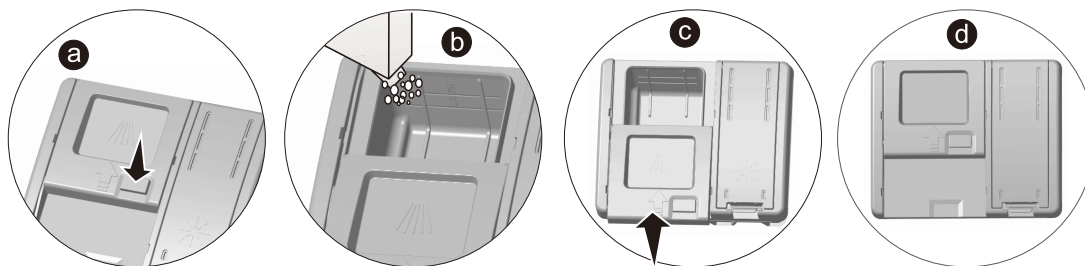

Attention

- Please use special detergent in the dishwasher in powder or block form, no detergent should be used and it is recommended not to use detergents containing chlorine and phosphates.
- Pay attention to the warning information on the detergent packaging and contact the detergent manufacturer if you have further questions.
- When using the Quick wash in the main program or the Half Load wash in the add-on function, it is not recommended to use wash block products, there may be cause a situation where the polyester block cannot be completely dissolved.

■ Adding rinse aid

A special rinse aid is required in the dishwasher. To ensure the drying effect, when the rinse aid light is missing "☼" When it lights up, please add rinse aid promptly. The rinse aid can be used multiple times with a single addition. Add the following steps:

1. Open the rinse aid cartridge lid as shown in figure (Figure a);
2. Add rinse aid until the "MAX (maximum)" scale is reached (Figure b);
3. Close the rinse aid cartridge lid (Figure c).

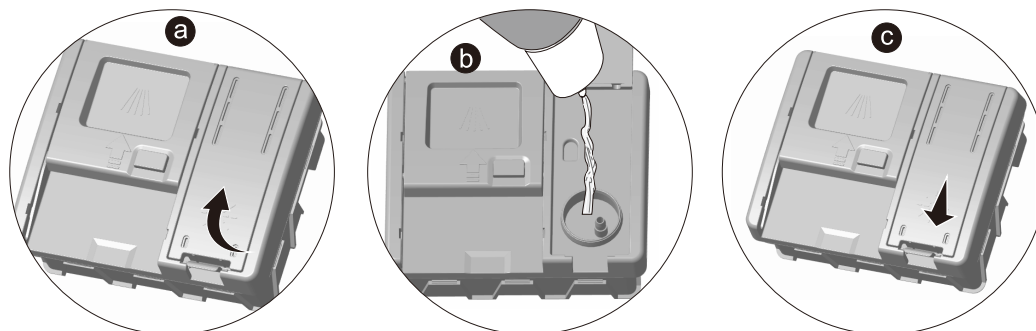

Note: If there is any spilled rinse aid, please wipe it off.

Put In the Tableware

Tableware type suggestions

- Ordinary ceramics (not including glazed porcelain), plastic (some thermoplastics may be deformed or faded due to high temperatures), glass (delicate glassware or crystal glassware containing lead may lose its luster after frequent cleaning), stainless steel tableware are generally available for dishwasher cleaning.
- Wooden tableware or utensils with wooden parts may be deformed or cracked due to high temperatures. The color coated glaze may fade after several washes. Copper, brass, tin and aluminum items may tarnish or fade after multiple washes. Dishwasher cleaning is not recommended.
- Iron products, aluminum products, and Teflon coated non-stick pans are not recommended for cleaning and are prone to rusting or chemical reactions after washing.
- Crafts, antiques, valuable vases and decorative glassware should not be washed in the dishwasher.
- Always check the instructions provided by the tableware manufacturer to see if the dishes are dishwasher safe.

Tableware placement diagram

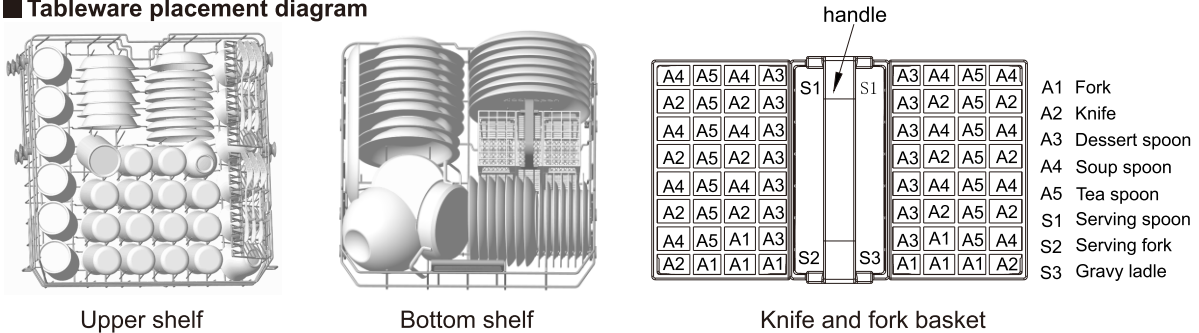

Standard storage capacity

7 dinner plates, 7 dessert plates, 7 dessert bowls, 7 mugs, 14 glasses, 7 soup plates, 7 melamine dessert plates, 7 saucers, 7 cups, 1 small pot, 1 oven pot, 1 glass bowl, 2 melamine bowls, 1 oval platter, 14 knives, 14 forks, 14 soup spoons, 14 dessert spoons, 14 tea spoons, 2 serving spoons, 1 serving fork, 1 gravy ladle.



- Remove larger food debris (bones, seeds, etc.) from dishes before placing them in the dishwasher.
- It is recommended to arrange the tableware as shown.

Tableware incorrect placement diagram

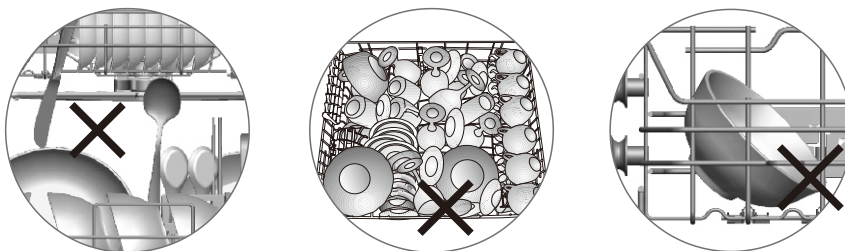

- The tableware is placed reasonably, please do not let the tableware block the rotation of the spray arm.
- Do not overlap or squeeze the dishes together in the shelves.
- Do not place dishes upwards.

■ Tea cup holder

The tea cup holder can be lifted up or laid down according to the direction of the arrow in the left figure, while the small bracket on the tea cup holder can be erected or lowered according to the direction of the arrow in the right figure.

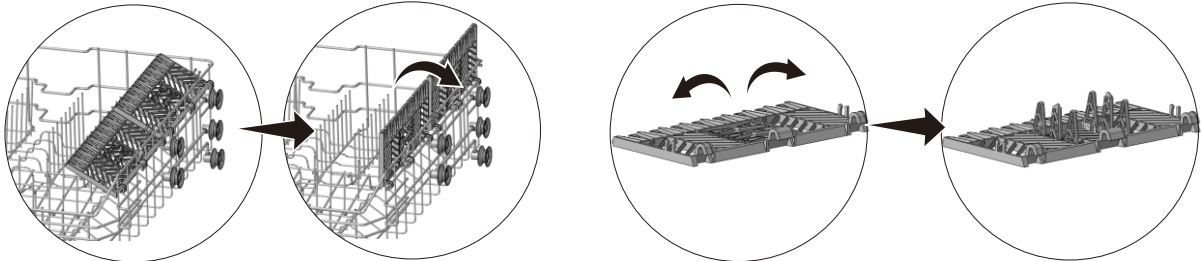

■ Knife and fork basket

The knife and fork basket can be used with the lid open for easy access; at the same time, the cage can be placed in different positions on the bottom shelf according to the placement of the washing utensils.

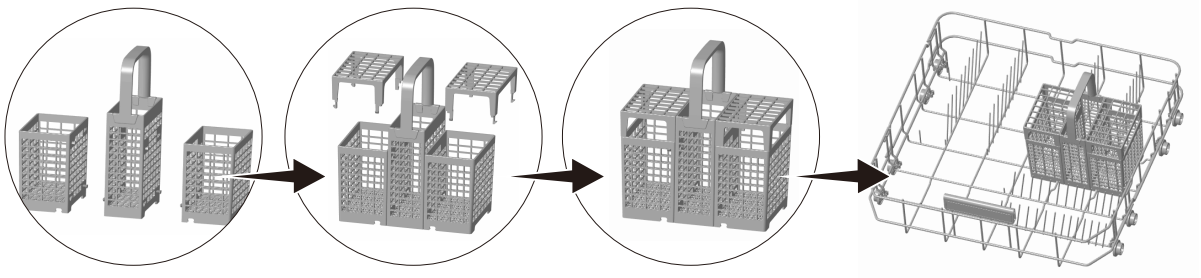

Program Settings

■ Turn on the dishwasher

Open the dishwasher door and long press "⏻" button to turn on the dishwasher and enter the program selection.

■ Start-up procedure

1. Select the program and press "▶" button to start
2. The program starts running after closing the dishwasher door.

⚠ Important: It is recommended to select the program depending on the type of items to be cleaned and the amount of food residue.

■ Additional Features

Additional features can be used as needed. Additional features include Half load, Anti-Bac, Dry, and Delay.

● Half load

Press " $\frac{1}{2}$ " key, select the bottom spray arm after working alone, cleaning a small amount of tableware, tableware should be placed in the bottom shelf.

● Anti-Bac

Press " Ⓜ^+ " key, select and then enhance the germ removal effect to enhance the germ removal of tableware.

● Dry

Press " Ⓜ " key to enhance the drying effect, the program ends automatically open the timed air change function; long press " Ⓜ " key to directly open the timed air change function;

● Delay

Press " Ⓜ " key to set the delay time. The delay time is optional for 1h-24h, each press increases 1h, long press " Ⓜ " key, the delay time is accelerated to jump. No delay time by default. After setting the delay time to start, long press " Ⓜ " key cancels the delay and returns to the program status.

Main program and additional function matching table

NO.	Main program/ additional functions	Half load	Anti-Bac	Dry	Delay
1	Intensive	●	●	●	●
2	ECO	●	●	●	●
3	Quick		●	●	●
4	AUTO		●	●	●
5	Glass	●			●
6	Quiet	●	●	●	●

Additional functions operation method:

1. Selecting the main program first, then followed by the additional functions;
2. Additional functions will be cancelled when the main program changes;
3. When the main program and additional functions cannot be overlapped, the corresponding additional function icon flashes and then lights off;
4. After the main program and additional functions are selected, press " ▶ " The program runs automatically after the door is closed.

■ End of program

All lights go off after the process finishes.

- Note:
1. Open the door during the process, and press " ▶ " key before re-running and then close the door, the process continues.
 2. After the machine starts, open the door and long press " ▶ " key to reset the program.

User Operation Settings

While the machine is on standby status, long press "🔊" key and "1/2" key for 3s simultaneously, enter the user setting interface, the digital tube shows dx(d0-d6), at this time you can set the rinse aid level; then press "🔊" key, the digital tube display Hx (H0-H8), at this time can be set for water softener regeneration gear; then press "🔊" key, the digital tube displays Lx (L0-L1), at this time, you can set the interior light; then press "🔊" key, the digital tube displays bx (b0-b1), at this time, you can set the sound. (See below for specific settings)

■ Rinse aid stall setting

When the digital tube displays dx(d0-d6), the current machine rinse aid setting level is displayed, press "1/2" key to enter the rinse aid stall setting and the digital tube displays d0-d6 cycle. d0 represents the least amount of rinsing dose, d6 represents the most, and the factory default setting is d4. If changes are needed, we recommend contacting local customer service.

■ Water softener regeneration gear setting

Digital tube display Hx (H0-H8), display the current machine water softening setting gear, press "1/2" key, enter the water softener regeneration gear setting, digital tube display H0-H8 cycle, the factory default setting is H5.

Water hardness and salt level comparison table

Water hardness (unit:ppm)	Gear	Water hardness (unit:ppm)	Gear
—	H0	221-290	H5
0-110	H1	291-380	H6
111-150	H2	381-540	H7
151-180	H3	541-890	H8
181-220	H4		

If the local water hardness is not within the H5 range, please adjust the water softener regeneration gear according to the actual water hardness, referring to the above-mentioned comparison table. If changes are needed, we recommend contacting local customer service.

■ Interior light settings

When the digital tube displays Lx (L0-L1), the current set gear of the machine interior light is displayed, press "1/2" button to enter the interior light stall setting and the digital tube displays L0-L1 cycle. L0 means the interior light is off, L1 means the interior light is on, and the factory default setting is L1.







■ Sound settings

When the digital tube displays bx(b0-b1), the current machine sound setting gear is displayed, press "1/2" key to enter the sound stall setting and the digital tube displays b0-b1 cycle. b0 means the buzzer has no sound, b1 means the buzzer has sound, the factory default setting is b1.

- Note:
- After the above settings are set, 10s without operation, the settings will be saved automatically and the machine will shut down and exit; you can also press "▶" key to save the setting manually and the machine turns into the program selection state.
 - All the above operations should be operated when the door is open.

Main Program

Main program description table

Procedures	Usage Scenarios	Amount of detergent	Running time	Operating temperature (Maximum)
 Intensive	Heavily soiled dishes, residual dry dishes.	Pre-wash cartridge: 6g Main wash box: 25g	150min	75°C
 Eco	Moderately soiled dishes that have not dried and cured.	Pre-wash cartridge: 6g Main wash box: 25g	218min	57°C
 Quick	Lightly soiled dishes, no drying required.	Main wash box: 15g	35min	50°C
 Auto	Automatic recognition to match the level of soiled dishes.	Pre-wash cartridge: 6g Main wash box: 25g	100min-150min	72°C
 Glass	Delicate and fragile lightly soiled tableware.	Pre-wash cartridge: 6g Main wash box: 25g	92min	50°C
 Quiet	Wash lightly soiled dishes that have not dried out at night.	Pre-wash cartridge: 6g Main wash box: 25g	238min	75°C

1. The above parameters, for reference only, the actual use of different ambient temperature, water temperature, water pressure and tableware will vary;
2. You can select the appropriate washing mode according to the degree of soiling of the dishes.

Installation



Important Notes:

1. After opening the package, check and ensure that no damage has been caused in transit. If the product is damaged, please do not connect the power supply and contact our after-sales service.
2. After installation is complete, make sure that the power cord or water supply and drainage hoses are not pressed.
3. Do not connect the dishwasher to the power supply throughout the installation process.
4. If you need to adjust the installation, please leave the electrical and plumbing related operations to the professionals.
5. Check that the dishwasher grounding is reliable.
6. All electrical and plumbing work during the installation of the dishwasher must be performed by a professional.
7. If your dishwasher is running abnormally, please cut off the circuit to shut off the water supply and contact the after-sales service.
8. For safety reasons, do not keep the dishwasher door fully opening after use.
9. Before first use, make sure to remove all packaging and fixing accessories.

ROBAM | Dishwasher

■ Dishwasher installation size

Dishwasher installation dimensions, must comply with the dimensions shown in the following figure (unit: mm).

NO.	Name	W	H	D
1	Full built-in cut out size (W×H×D)	600	820-860	≥575

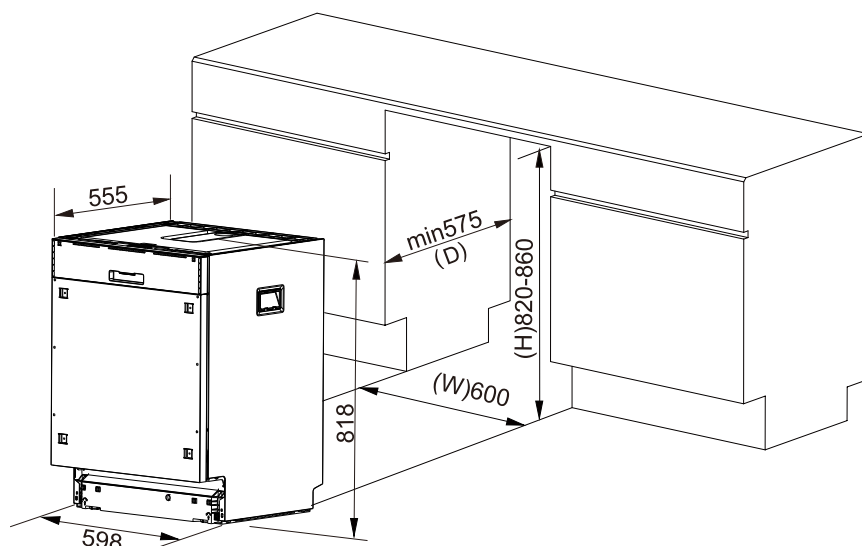

Installation package	
A	Anti-steam sticker (1pc)
B	Clamps(2pcs)
C	ST3.5×30mm (4pcs)
D	Drain pipe support (1pc)
E	Salt filling funnel (1pc)
F	ST4.2×10mm (6pcs)
G	ST4×40mm (4pcs)
H	Decorative pegboard fixings(4pcs)
I	Installation template (1 sheet)

■ Connection to water supply

1. Check and ensure the water pressure: 0.1MPa-1.0MPa; you can contact the local water supply agency to consult the local water pressure, if the water pressure is too high, please install a regulator.
2. Dishwasher hose connection for water supply: connect the threaded end of the hose to the triangle valve (faucet), the thread of the water inlet fitting for this machine is G3/4".

WARNING: New hose-sets supplied with the appliance are to be used and that old hose-sets should not be reused.

Attention

- ※If the water pipe is new or not used for a long time, you should open the water valve and let the water flow for a while, until the water becomes clear and free of impurities before connecting to the dishwasher inlet pipe.
- ※Check if the hose seal is intact and the connection is tight (Figure A).

- ※Avoid twisting and compression of the hose (Figure B).
- ※When the dishwasher is not in use, turn off the water tap.

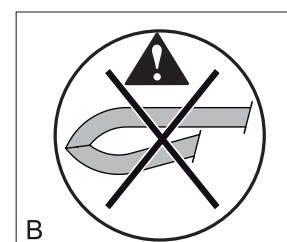
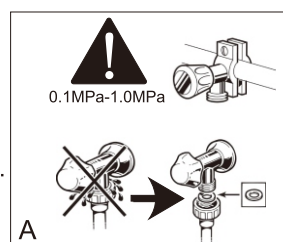

■ Wastewater discharge

1. You can connect the end of the drain hose to a vent U-bend or a sink U-bend; when connecting to a U-bend, the top baffle must be removed and the rubber end fully installed, using clamps if necessary.

Note: Make sure to secure the drain hose in place to prevent leaks.

2. When the drainage pipe is installed, the highest drainage port does not exceed the height of the whole machine, and the drainage port is strictly prohibited to be submerged in water.

⚠ Important: When installing the hose, slowly pull the hose, such as hose kink, compression, may interrupt the water flow or reduce the flow rate; drainage pipe more than 3 meters will affect the normal operation of the dishwasher.

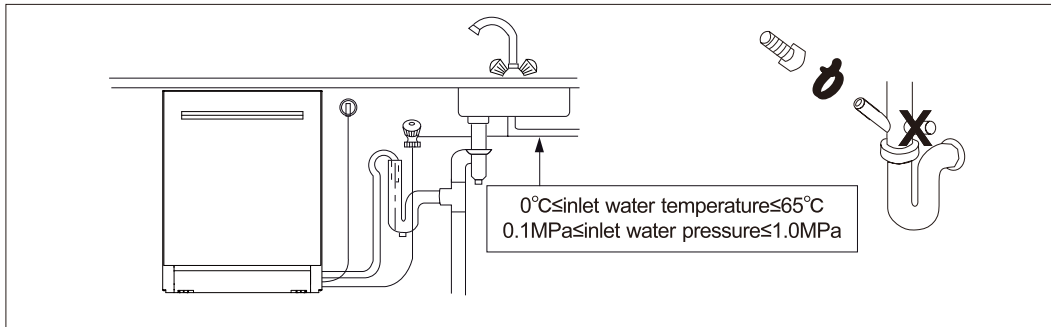

■ Electrical connection

Before connecting the dishwasher ensure that:

1. The electrical connection information on the product nameplate sticker must match your power requirements;
2. The dishwasher must be connected to a dedicated outlet with grounding;
3. If it is necessary to connect to a voltage different from that stated, an appropriate transformer must be used and a suitably qualified electrician must adjust and ensure that the electrical installation complies with the regulations.

- ⚠ Warning:**
- After installation, please make sure not to cover the socket.
 - Do not connect power through patch panels, duplex sockets or electrical delay devices (as shown below).
 - The Company will not be responsible for any accidents caused by missing grounding devices or grounding faults.

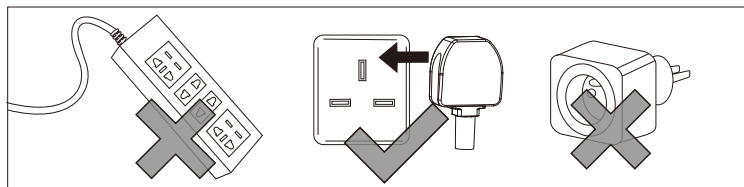

■ Installation steps (dimensions shown in the figure is mm)

Step 1

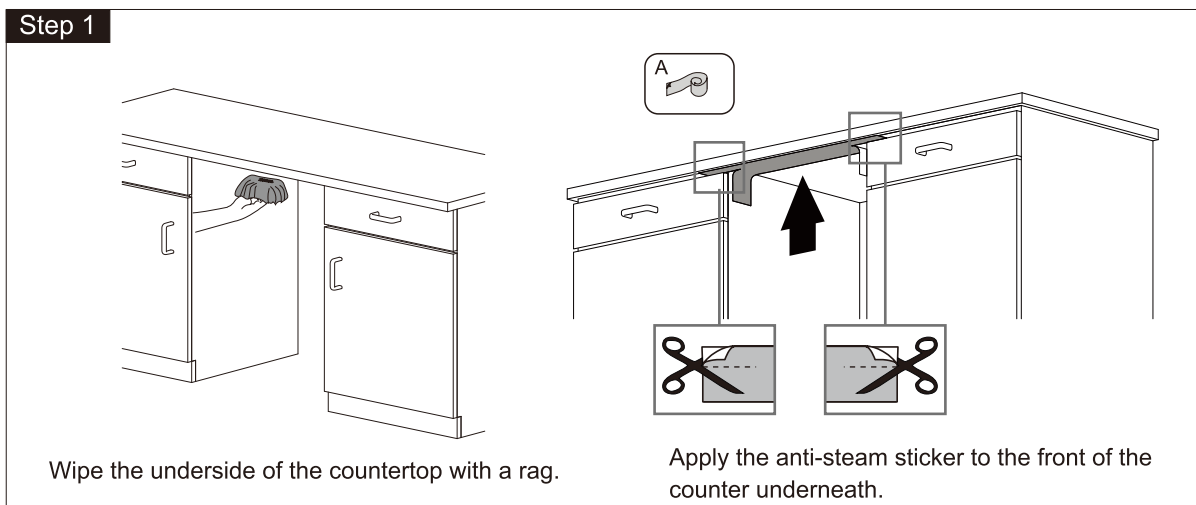

ROBAM | Dishwasher

Step 2

Pushing the dishwasher slowly, the inlet drain and power cord extend from the bottom or side, no twist.

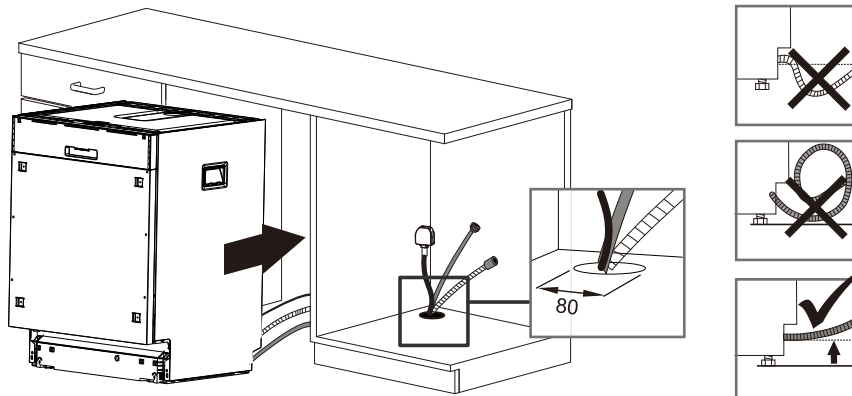

Step 3

Rotate the bottom foot, the height of the whole machine will be raised clockwise and lowered counterclockwise.

Using a special hexagonal adjustment tool. Adjust the height of the whole machine by inserting the hexagonal tool into the hexagonal hole in the diagram according to the direction of the two arrows on the left side of the diagram.

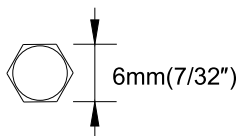

The front of adjustment tool.

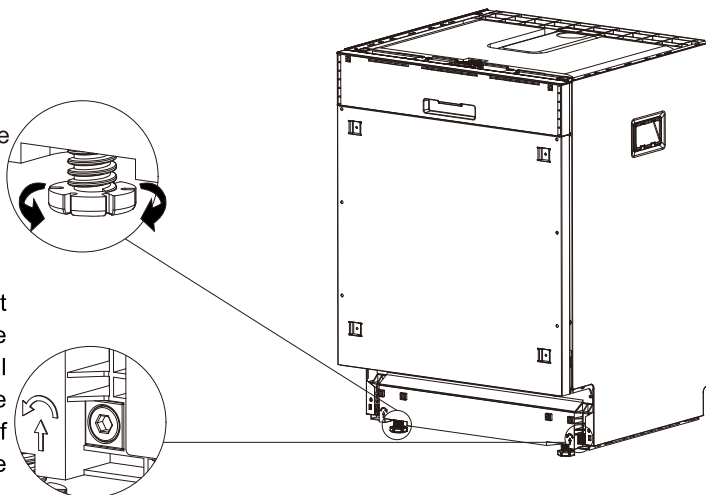

Step 4

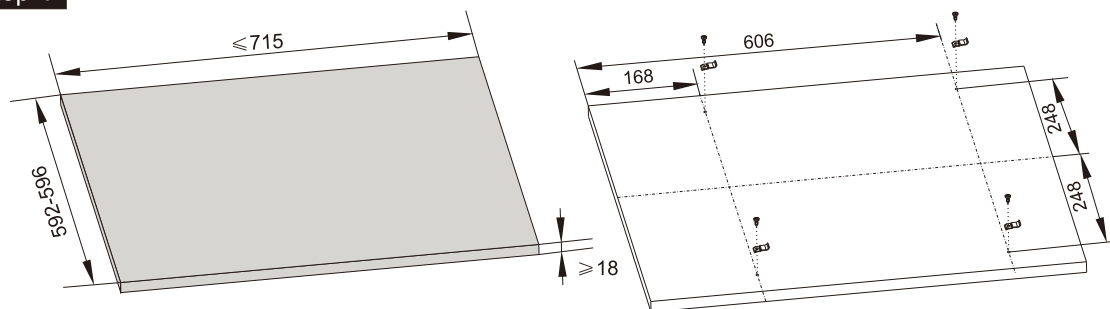

Use ST4.2×10mm screws to lock the decorative pegboard fixings in the corresponding position of the decorative pegboard (customized by user) (can be positioned with the accessory installation template), such as the user's own door panels need to meet the specifications shown in the left figure.

Step 5

Make the decorative peg plate stick to the dishwasher door and slide it downwards, with the decorative peg plate fixings stuck into the corresponding slots.

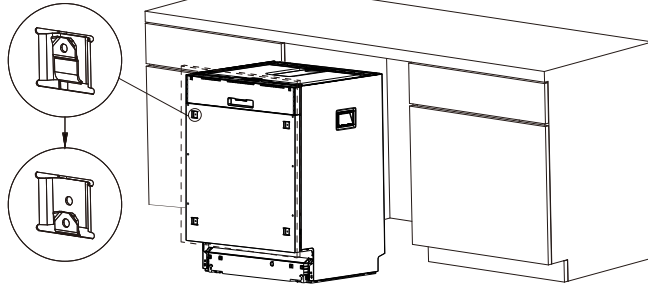

Step 6

Push the dishwasher completely into the cabinet and open the dishwasher door and remove screws 1 and 4.

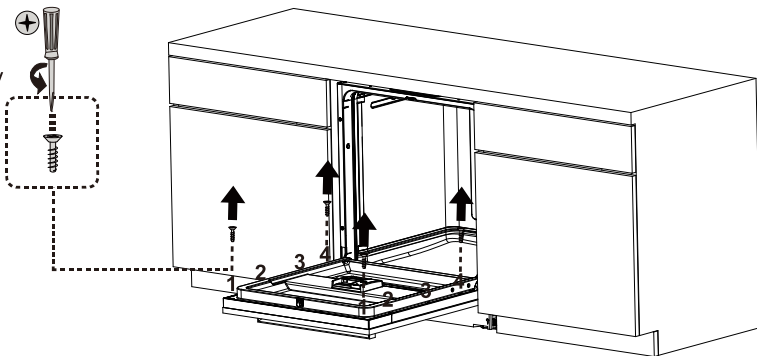

Step 7

Use ST4×40mm screws to fix the decorative plate fixings in position 1 and 4.

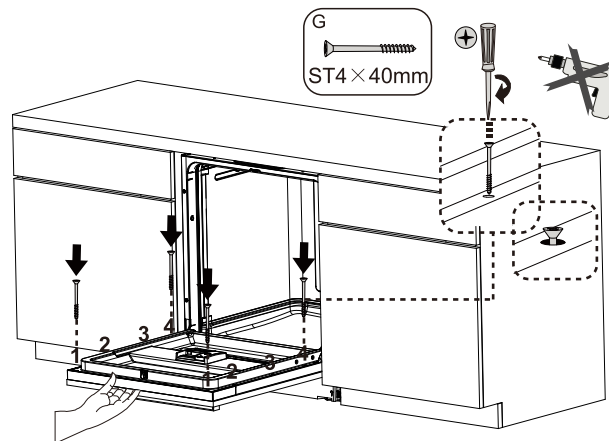

Step 8

After opening the door, install the fixing screws on both sides.

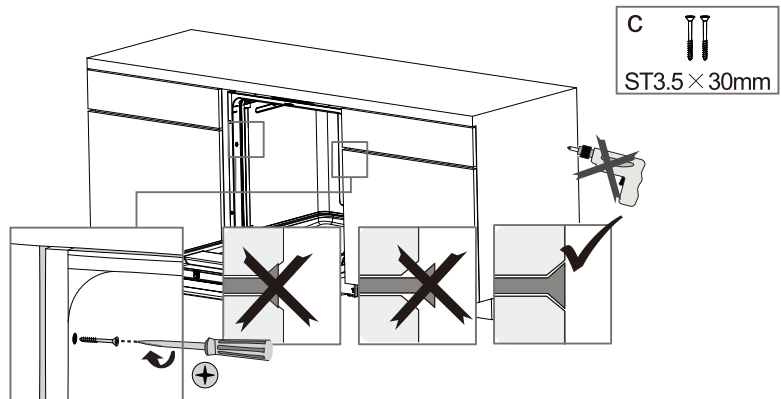

Step 9

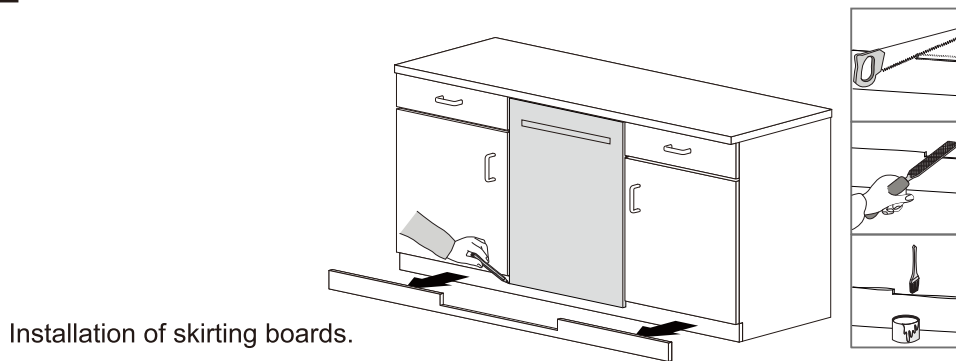

Installation of skirting boards.

Step 10

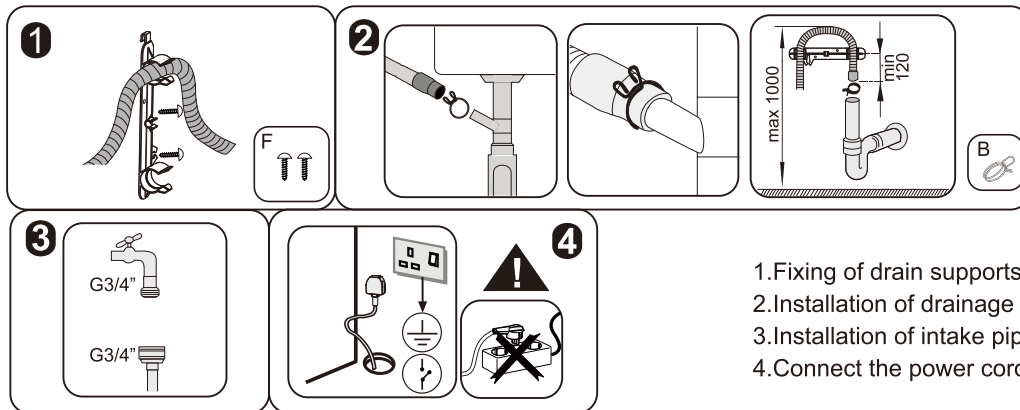
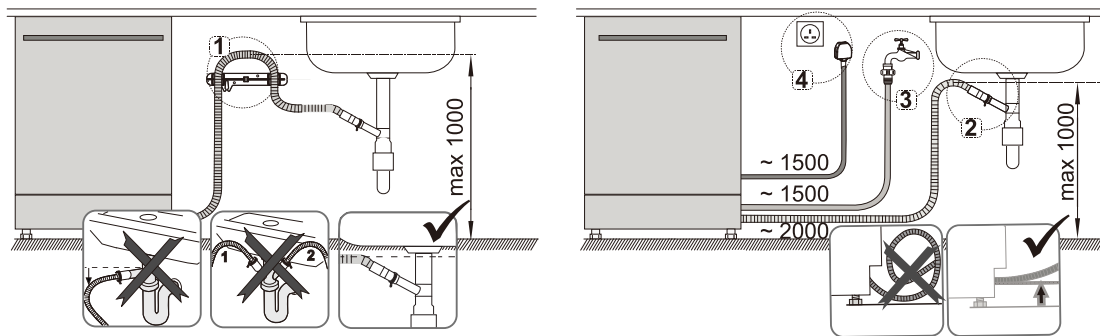

1. Fixing of drain supports;
2. Installation of drainage pipes;
3. Installation of intake pipes;
4. Connect the power cord.

Maintenance

■ Clean this product regularly

Regular cleaning of this product will prolong its life and reduce some common problems.



Attention

- You must unplug the power and turn off the faucet before cleaning.
- No substances of abrasive nature should be used for cleaning.
- To ensure efficient operation of this equipment, the filter and spray arms should be cleaned at least once a week.

■ Clean the outer surface of this product

Use a neutral cleaning material and a damp rag to wipe the outer surface of this product. Use only a slightly damp cloth to wipe the "control panel".

■ Cleaning the inside of the dishwasher

※ Based on the degree of soiling, determine whether to add detergent and then run the program to clean the inside of the dishwasher and the water tank.

※ If water remains in the dishwasher, remove the filter as described in "Cleaning filters" below and check the bottom of the dishwasher for any residue that may have accumulated and caused a block in the water line. Clean as needed.

■ Cleaning filters

To ensure efficient operation of this equipment, the filter should be cleaned at least once a week. Check for food residue on the filter. If there is food residue on the filter, remove the filter and rinse it by water.

1. Turn the fine and coarse filter assembly approximately 1/4 turn counterclockwise and withdraw the fine and coarse filter assembly from the base.
2. Press the two jaws of the coarse filter inward and separate the coarse filter from the assembly.
3. Using a brush, clean the removed filter by water.
4. Placement of fine and coarse filtration components.
5. Put the coarse filter back into the fine filter. Make sure it is properly snug. Turn the fine and coarse filter assemblies clockwise until the arrows of the fine filter line up with the arrows of the flat filter screen.

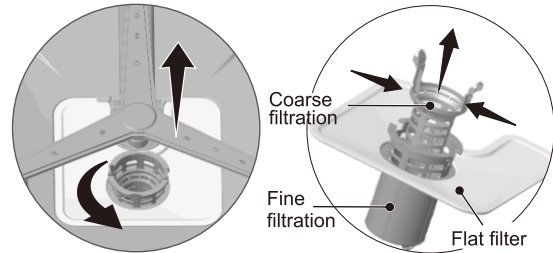

- ※ Do not use the dishwasher without a filter installed.
- ※ Improper placement of the filter will reduce washing effect.

■ Clean spray arms

1. Check that the hole in the bottom spray arm is not blocked. If blocked, disassemble and clean the bottom spray arm. Pull down the bottom spray arm upward to check the processing.
2. Check if the hole in the middle spray arm is blocked. If blocked, disassemble and clean the middle spray arm. Turn the middle spray arm fixing piece in the direction of the arrow to remove the middle spray arm.
3. When installing the middle spray arm, be sure to fully tighten the middle spray arm retainer.

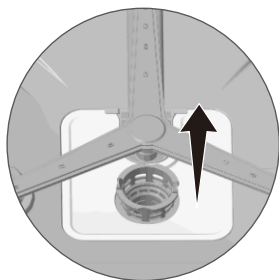

Take out the bottom spray arm

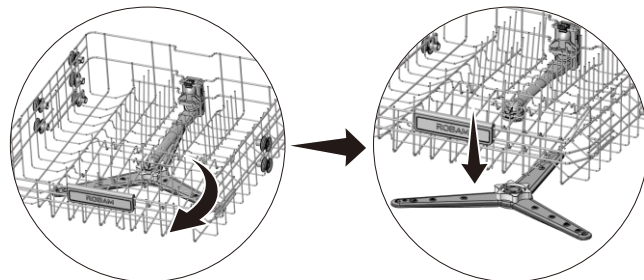

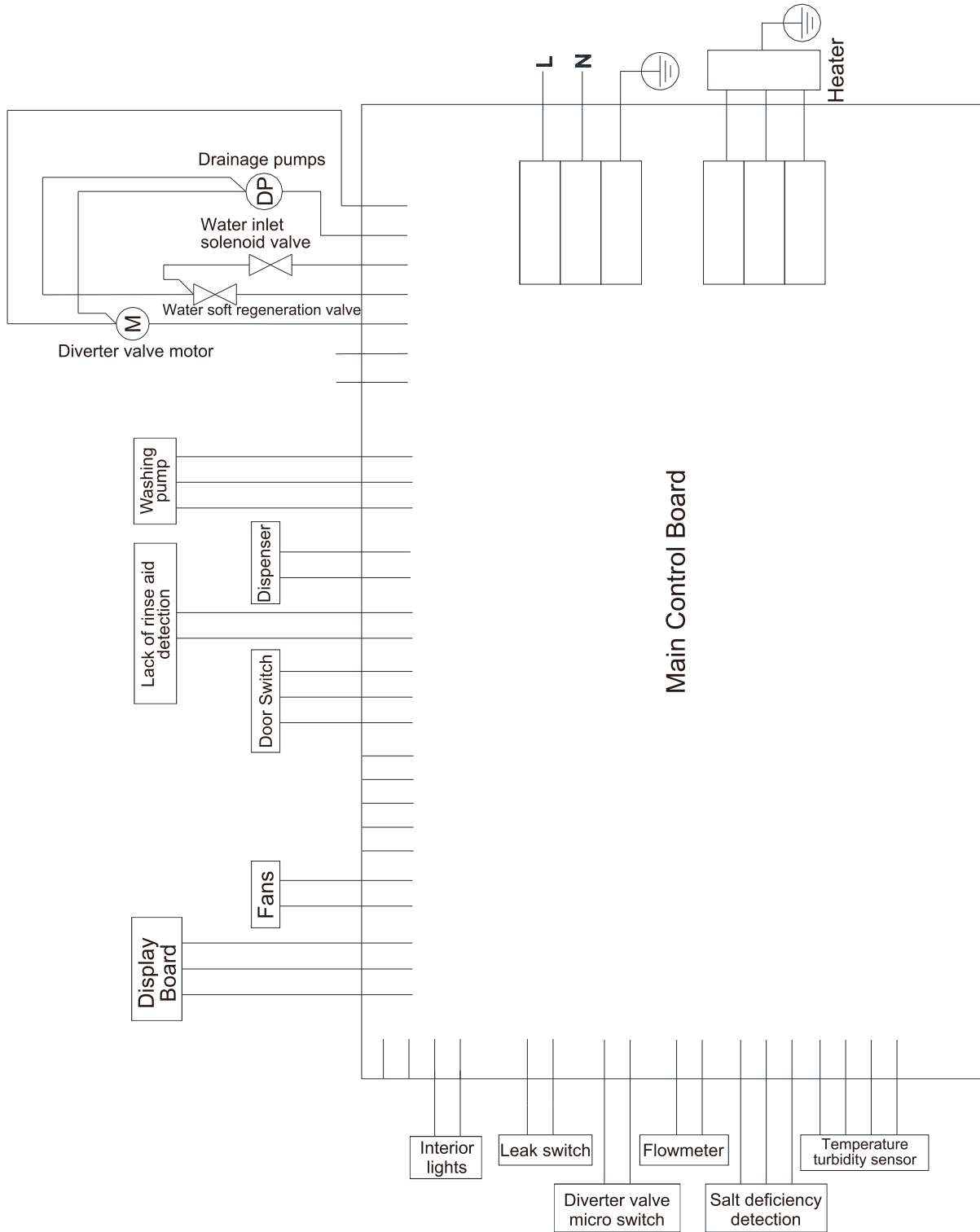

Removal of middle spray arm

Circuit Diagram



Troubleshooting of General faults

Common fault codes	Reason	Processing method
E1	Abnormal water inlet alarm	Check whether the faucet is open; Whether the water inlet pipe is bent; If not yet resolved, please contact a professional technician for consultation or repair.
E3	Abnormal heating alarm	Please contact a professional technician for consultation or repair.
E4	Water overflow alarm	Please contact a professional technician for consultation or repair.
E5	Temperature sensor alarm	Please contact a professional technician for consultation or repair.
E6	Communication abnormal alarm	Please contact a professional technician for consultation or repair.
E7	Flow meter alarm	Please contact a professional technician for consultation or repair.
E9	Fault alarm of water distribution valve	Please contact a professional technician for consultation or repair.
E10	Motor fault alarm	Please contact a professional technician for consultation or repair.
	Lack of rinse aid indication	Add rinse aid.
	Salt deficiency indication	Add special salt.
	Water shortage indication	Turn on the faucet and if it is not resolved, contact a professional technician for consultation or repair.

Tip: If the above malfunction occurs, you must ask maintenance personnel to repair and inform them of the information displayed (E1, E3, E4).....)

Question	Possible reasons	Processing method
Cleaning effect is not good	<ul style="list-style-type: none"> ※Check whether forget to put in detergent; ※Check whether non-dishwasher-safe detergent is put in; ※The spray arm is jammed; ※Improper placement of cutlery (covered by larger cutlery or located at the bottom, cutlery set together or stuck together) is correctly positioned; ※There are burnt dishes not pre-cleaned; ※Blocked filters; ※Use mineral-rich water such as well water. 	<ul style="list-style-type: none"> ※Please put the right amount of detergent according to the degree of stain; ※Please put in dishwasher detergent; ※To ensure that the spray arms operate properly without jamming; ※Reasonable arrangement of all types of tableware; ※Pre-cleaning of dishes; ※Please clean the filter.
Detergent is not completely dissolved	<ul style="list-style-type: none"> ※Detergent is damp or caked. 	<ul style="list-style-type: none"> ※Please crumble it before putting it in the dishwasher.
Glassware becomes white and opaque	<ul style="list-style-type: none"> ※Glass tableware with small surface defects washed with high temperature washing water, occasionally becoming white and opaque; ※Do not put in crystalware because it will become white and opaque; ※greasier stains, which may have oil residue; ※The salt filling level is not set properly. 	<ul style="list-style-type: none"> ※Not recommended for cleaning; ※More special detergent; ※Reset the salt addition level.
Water accumulation at the bottom of the tableware	<ul style="list-style-type: none"> ※Improperly placed dishes or insufficient drying time. 	<ul style="list-style-type: none"> ※Correct placement of dishes to prolong drying time.

ROBAM | Dishwasher

Question	Possible reasons	Processing method
Tableware does not dry	<ul style="list-style-type: none"> ※Rinsing aid is used up; ※The rinse aid dosage is set too low. 	<ul style="list-style-type: none"> ※Re-add rinse aid and select the appropriate program; ※Increase the rinse aid dosage setting.
Excessive sound during operation	<ul style="list-style-type: none"> ※Blocked filters; ※Put in dishes with too much food residue. 	<ul style="list-style-type: none"> ※Please clean the filter; ※Pre-removal of excessive food residues.
The utensil falls under the bowl holder, causing the spray arm to jam	<ul style="list-style-type: none"> ※Light dishes are thrown out due to washing water spray. 	<ul style="list-style-type: none"> ※Please take out the utensils and place them in the corresponding correct position.
After using for a long time, the inside of the dishwasher becomes white	<ul style="list-style-type: none"> ※The water contains mineral components. 	<ul style="list-style-type: none"> ※This is a normal phenomenon and not a malfunction.
Stagnant water under the filter	<ul style="list-style-type: none"> ※Water accumulation at the bottom is normal. 	<ul style="list-style-type: none"> ※This is a normal phenomenon and not a malfunction.
Drain immediately after starting operation	<ul style="list-style-type: none"> ※Because clean water is used for cleaning, the water inside the pump is discharged. 	<ul style="list-style-type: none"> ※This is a normal phenomenon and not a malfunction.
Odor during use	<ul style="list-style-type: none"> ※After a period of purchase, there may be machines (rubber and resin) odor. 	<ul style="list-style-type: none"> ※This is a normal phenomenon and not a malfunction.
Drains and other odors	<ul style="list-style-type: none"> ※If you don't use it for a long time, it may give off an odor because the water in the drainage pipe evaporates. 	<ul style="list-style-type: none"> ※Use the "Quick" program after running it once.
Water Outage	/	<ul style="list-style-type: none"> ※Cut off power and stop operation; ※After the water supply is restored, please open other taps first and run again after draining the cloudy water.
Water droplets on the inner wall and bowl basket at the end of the procedure	<ul style="list-style-type: none"> ※The characteristic of residual temperature drying. 	<ul style="list-style-type: none"> ※It is a normal phenomenon, not a malfunction.
Plastic tableware is not dry	<ul style="list-style-type: none"> ※Characteristics of plastic products. 	<ul style="list-style-type: none"> ※The plastic has low heat transfer coefficient and poor heat storage capacity, so the drying effect will be unsatisfactory.

Note: If the above phenomenon still can not be ruled out, please contact the dealer, non-professionals are strictly prohibited to disassemble and install this machine by themselves.

Edition: A/0

Publication Date: July, 10, 2023

ROBAM