

ROBAM



User Manual

Before operating this unit, please read the user manual completely and keep it. If the manual is lost, you can send e-mail to overseas@robam.com, request for an electronic manual.

CXW-200-A609

CXW-220-A610

Range Hood

CONTENTS

Safety Precaution.....	1
Important Information.....	4
Product Overview.....	5
Packing List.....	5
Installation.....	6
Use Instruction.....	8
Maintenance and Services.....	9
Prats Removal.....	9
Circuit Diagram.....	11
General Troubleshooting.....	11

Dear users:



Thank for your buying our range hood. Please accept our best regards. Please read this user manual carefully before installation and operation.

*The pictures in this manual only for your reference. If the picture isn't accord with object, subject to object. We keep to right to update appearance, structure or products without notice.

Safety Precaution

In order to avoid harm or property damage to the users or other person, the following distinction and marks are stipulated. They are important safety precaution, please comply strictly based on the full understanding.

Subject to harmful or destruct degree





 Danger	If ignore this sign and operate product improperly, it's highly possible to cause danger, serious injury or fire.
 Warning	If ignore this sign and operate product improperly, it's possible to cause danger, serious injury or fire.
 Notice	If ignore this sign and operate product improperly, it's possible to cause injury or loss.

Notice and Prohibit Mark



 Prohibit	 Prohibit Flame	 Prohibit Touch	 Prohibit Touch by Wet Hand	 Prohibit Disassembly	 Strict Execution	 Necessary Earthed	 Caution Electric Shock	 Caution Scald
---	--	--	--	--	--	--	--	---

 Warning Please use this product according to manual strictly, or ROBAM shall not take any responsible caused by improper operation.







Danger

 Prohibit	Don't allow children or weakling to use range hood separately, or it may cause electric shock or other accident.
 Prohibit	Prohibit water on motor, switches or other electric parts; Prohibit wash range hood by water spray. Don't use range hood if wet or it may cause electric leakage or shock.
 Prohibit	Don't change, stretch, bind or press electric wire, or it's possible to cause electric shock or fire because of broken wire.
 Prohibit	Prohibit any change of interior circuit, or it may cause injury or other danger, for example, electric shock or fire.
 Prohibit Touch by Wet Hand	Don't touch plug, electric parts or button by wet hands, or it may cause electric shock.







Danger

 Strict Execution	<p>The electric wire must be cut off before clean, install or maintain range hood avoiding from electric shock.</p>
 Strict Execution	<p>Please turn off range hood immediately if pan got fire (range hood shall aggravate fire if it's working) and extinguish fire by effective action. For example, cover flame by metal cover, turn off gas valve immediately and remove inflammable things.</p>
 Strict Execution	<p>Any abnormal, please turn off power, take off plug or cut off electric source, and contact service. It's possible to cause electric shock or fire if using range hood under abnormal situation.</p>



Warning

 Prohibit Disassembly	<p>Range hood must be installed, disassembled or maintained by professional person.</p>
 Prohibit	<p>Put out the stove fire in time when it is not used. That the stove fire bakes the range hood directly is prohibited. Do not barbecue food directly under the range hood lest the range hood is damaged and an accident should occur.</p>
 Prohibit Touch	<p>Don't touch bulb if it's on or just close in short time, or it may cause scald.</p>
 Strict Execution	<p>In order to ensure safety, range hood must be installed by specific accessory (especially expansion pipe and wooden screws, or it may cause accidental drop of range hood). The pipe bore and hole must fit tightly during the installation of metal expansion pipe. It is prohibited to make excessively large hole to prevent accidental drop of loosening expansion pipe.</p>
 Strict Execution	<p>The range hood must be used by specific plug and properly ground it. It's possible to cause electric shock, hot plug or fire because of improper electric wire. Installation must be executed by professional person based on local electrical regulations. Before connect electricity, power must be turned off.</p>
 Strict Execution	<p>If electrical wire is broken, only professional engineer can replace it.</p>

Warning

 Strict Execution	<p>All operation must comply with our safety guidelines as well as local safety regulations.</p>
 Strict Execution	<p>If the range hood will be used with the kitchen range burning gas or other fuels, the room must be well ventilated.</p>
 Strict Execution	<p>The range hood is used only daily life not special environment (for example, outside). And it's not allowed to exhaust dangerous or explosive matter or air. It should be put under dry and ventilation environment without dangerous air.</p>
 Strict Execution	<p>The range hood and electric circuit must be installed by skilled and trained personnel with required qualification. When installation, the related regulation, standard or instruction on fire must be complied. It may cause danger because of improper installation, for example, electric shock, drop or fire accident.</p>
 Strict Execution	<p>The outlet must be connect with outside. In order to ensure safety and fresh air, waste gas should be exhaust to outside. Don't exhaust waste gas to the wall, loft or garage.</p>
 Strict Execution	<p>It may get fire if cleaning range hood not in accordance with manual.</p>
 Strict Execution	<p>Keep a good habit to turn off gas hob and gas valve if go outside, sleep or finish operation. Replace or check gas pipe regularly, since gas alarm device can't completely avoid accident caused by gas leakage.</p>

Notice

 Prohibit	<p>The gas from range hood shall not be exhausted to hot flue used for burning gas or other fuels.</p>
 Strict Execution	<p>The temperature for range hood working can't exceed 40°C.</p>
 Strict Execution	<p>Because the installation is difficult and hood is heavy, the installation shall be executed by professional person based on manul.</p>

Notice



Before removing range hood for installation, clean or maintenance, power must be cut off avoiding from electric shock. When installation, clean or maintenance, protective gloove must be wear avoiding from injury.



Don't break electric wire or other invisible equipment when cutting something or drilling holes on ceiling.



When range hood is using in well sealed building, it should have air inlet or open door to ensure good ventilation.



When the oil exceeds 2/3 or near tick mark in the oil cup, clean it in time. Don't eat waste oil from oil cup.



The wall of installing range hood needs enough strength. For hollow walls, the thickness of solid layer of hollow wall must be more than 30mm, but for concrete walls, it can be drill holes directly. The range hood must be fixed on the wall firmly.

Important Information

Package of Range Hood

Please settle those packages carefully in order to protect environment.

Don't allow children to play plastic film and package, it may cause asphyxia. Please avoid children near package material.

Before use Range hood

This range hood exhaust fume outside.

Please read this manual and all information carefully before installation and operation. Please comply with our suggestion. If it's necessary, please read manual for gas hob. And please keep these manual carefully for future reference.

This manual is available for different models. So you may find different description with your own range hood.

If range hood has obvious damage, please don't electrify and contact operator.

This appliance is not intended for use by persons (including children) with reduced physical, sensory or mental capabilities, or lack of experience and knowledge, unless they have been given supervision or instruction concerning use of the appliance by a person responsible for their safety.

Children should be supervised to ensure that they do not play with the appliance.

Product Overview

Product Parameter

Model	CXW-200-A609 CXW-220-A610	Noise	A609: ≤57dB A610: ≤58dB
		Rated Whole Machine input power	A609:204W A610:224W
Power Supply	220-240V~ 50Hz	Rated Main Motor input power	A609:200W A610:220W
Total Pressure Efficiency	≥23%	Max lighting power	≤2W×2
Nominal Pressure	≥290Pa	Dimension (L×W×H)	595×350×569(mm)
Air Flow Rate	17m ³ /min	Net weight	19kg
Maximum Static Pressure	400Pa	Grease separation degree	≥92%
Normal Odor Reduction Degree	≥98%	Instantaneous Odor Reduction Degree	≥80%

Note: The tolerance of air flow rate or max static pressure between testing value and actual value should be within 10%.

Size&Dimension

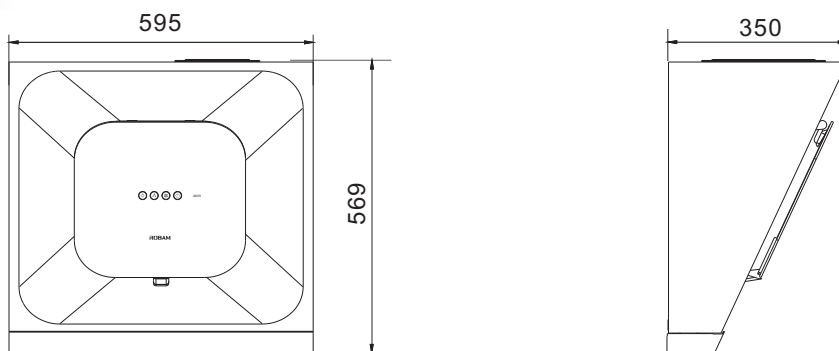

Labeled dimensions are only for reference (Unit: mm)

Packing List

Please check lists if open the package.

Packing List	No.	Name	Quantity	No.	Name	Quantity
	1	Range Hood	1 piece	8	Check Valve	1 set
	2	Ø175 (Outer Diameter) Aluminum Foil Air Duct	1 set	9	ST4x18 Self-Tapping Screw	10 piece
	3	Ø175 (Outer diameter) Air Duct Interface		10	ST4x60 Wooden Screw	4 pieces
	4	Fixed Bar Of Air Duct		11	Hitching Leg Stop Block	1 piece
	5	Adhesive Tape Of Air Duct		12	M6 Metal Expansion Pipe	1 pair
	6	Plastic Expansion Pipe	4 pieces	13	Hitching Leg	1 piece
	7	User Manual	1 piece	14	Oil cup	1 piece

Installation

Warning

- 1.The air must not be discharged into a flue that is used for exhausting fumes from appliances burning gas or other fuels,the discharge of air must fulfill the requirements of local regulations.
- 2.Note that when installing the metal expansion pipe, the pipe shall match with the hole in size. Overlarge hole is prohibited, as it will result in loose pipe and accidental drops.
- 3.There shall be adequate ventilation of the room when the range hood is used at the same time as appliances burning gas or other fuels.
- 4.If the flue aperture is less than air duct aperture, it will influence the fume suction effect and the too long air duct will influence the fume suction effect, too.
- 5.This product is only for daily use and please do not use it under special environment (e.g. outdoor); nor can it be used to exhaust hazardous or explosive substance or gas. Before assembly, the product shall be placed in environment which is dry, ventilated without corrosive and harmful gas in the surrounding.

Preparation Before Installation

●Surrounding environment

Range hood shall be avoided to be installed at the place where there are many doors and windows since it will cause too large cross-ventilation so as to influence the oil fume exhaust effect.

●Tool preparation

The following tools shall be prepared when range hood installation: 1. Electric impact drill (with drill); 2. Wrench; 3. Screw driver; 4. Ruler

Installation Notice

- Installation and circuit setting must be operated by professionals with experiences and non-professionals shall not assemble, disassemble and repair range hood.
- Don't connect power before installation, it may cause electric shock.
- If your kitchen is in decoration state, please do not expose the range hood outside since construction material, dust, paint, coating and the gases they volatile will corrode the surface of range hood and the surface will be tarnished. Therefore, it's suggested to assemble the range hood after decoration.
- If gas hob needs to be removed before installing range hood, please turn off gas valve firstly.
- Don't install range hood on the wooden or other flammable wall. The wall of installation range hood shall be on the nonflammable, enough stable, smooth and level surface.
- Range hood may have very sharp edge, please wear protective gloves while moving the range hood for installation, cleaning or maintenance.
- When drilling holes on the wall, the electric wire buried in the wall shall be avoided to prevent from fire.
- Range hood shall not be installed too high, nor shall it be disturbed by external air flow so that the fume suction effect will not be influenced.
- Please retain installation space for hood while fabricating cupboard so as for the care and maintenance .
- Please keep the hood body level while installing the machine.
- Please use single phase socket with earthing, which shall be well earthed.(Water pipe grounding is not reliable.The grounding of gas piping may cause the danger of fire and explosion.)
- Use appointed accessories for installation or range hood may fall down and cause danger.
- If the supply cord is damaged, it must be replaced by the manufacturer, its service agent or similarly qualified persons in order to avoid a hazard. Don't stretch, change ,tie, or press supply cord, or it may cause fire or electric shock.
- If finish installation, clean range hood firstly, then connect power and test run.

Installation

Note: All data units in the following figures are in mm

Picture 1

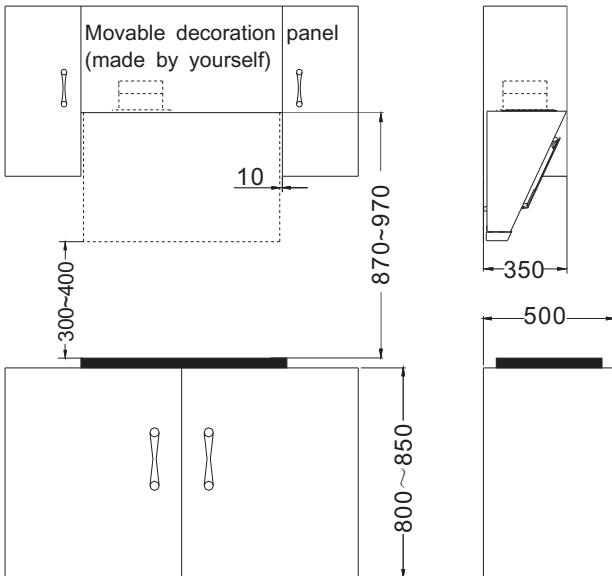

Cupboard dimensions are only for reference.

Picture 2

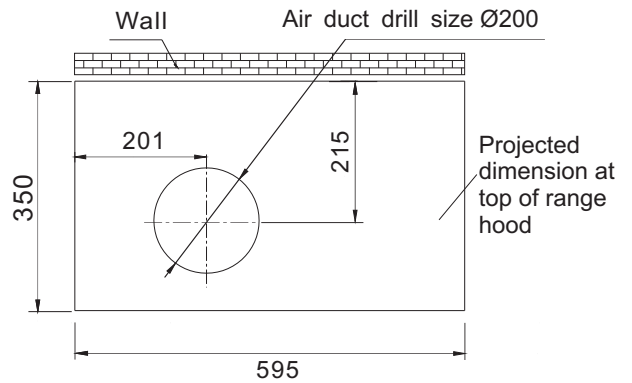

Hung ceiling drill size drawing
(Projected dimension at top of range hood)

● **Determine the position:** keep two holes level, and the size of two holes as picture 3; See picture 2 for hung ceiling drill size.

Picture 3

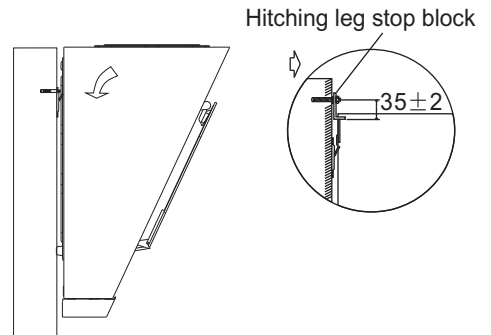
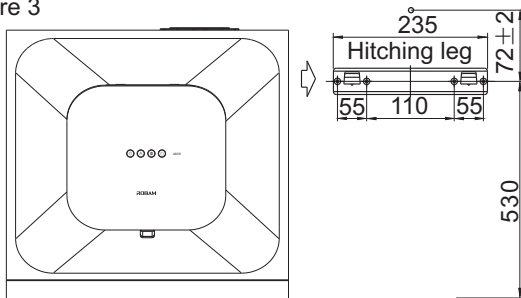

● **Install hitching leg:** According to the size of hitching leg in the corresponding position of the wall, drill 4 holes which depth is 60-70mm with a diameter of 8mm drilling tools. (Don't be too large). Then, insert expansion pipe to the holes and fix hitching leg firmly with 4pcs of ST4X60 wooden screws. At the distance of 72mm with 4 holes, drill a hole with 10mm diameter (not too large) and 50-55mm depth, then insert M6 metal expansion pipe as picture 3.

● **Install the machine body:** Fix check valve as shown in picture 4, and then according to picture 3 shown, put the hitching hole at the back of the hanging hole to press the peg, shaking the body with the hand to check whether it's steady. After machine body is installed in a place, on the M6 metal expansion pipe, install the hitching leg stop block, a gasket, tighten the nut (to prevent the machine body dropping under the action of external force accidentally).

● **Install ALUM-NOD:**

Hole position of ALUM-NOD (No need to drill holes in public flue)

a. **Installation of air duct and coil base directly facing window:** Disassemble a glass and assemble plywood with exhaust holes, or drill holes on the glass directly.

b. **When coil base is not close to window:** Select the nearest coil base, install the air duct on the window accessible to outdoor to penetrate the window; or select the nearest coil base, drill hole on the wall accessible to outdoor and install air duct to penetrate the wall.

c. **Drill the wall opening:** Measure the position that air duct faces wall and mark the drilling scope on the wall surface (i.e. circle a little larger than outer diameter of air duct), then use long drill to drill the wall. Pay attention to the wall structure and material while drilling and do not damage the wall besides wall opening.

2. Connect the ALUM-NOD

First connect the ALUM-NOD without air duct fixed strip with air duct interface, sealed by adhesive tape of air duct and straighten the ALUM-NOD to outdoor directly. When the wall hole is larger than ALUM-NOD, the air duct can be pulled to outdoor directly; when the wall hole is smaller than air duct, it can be selected according to the hole size since the small end of air duct interface has four specifications: 140, 150, 160 and 170. The surplus part that is smaller than wall hole can be cut by scissor.

Then insert the other end of ALUM-NOD with air duct fixed strip between internal and external ring of check valve outlet and seal it by adhesive tape of air duct. Last, put the 4 fasteners into the slots and rotate clockwise, the ALUM-NOD is fixed on the check valve.

Picture 4

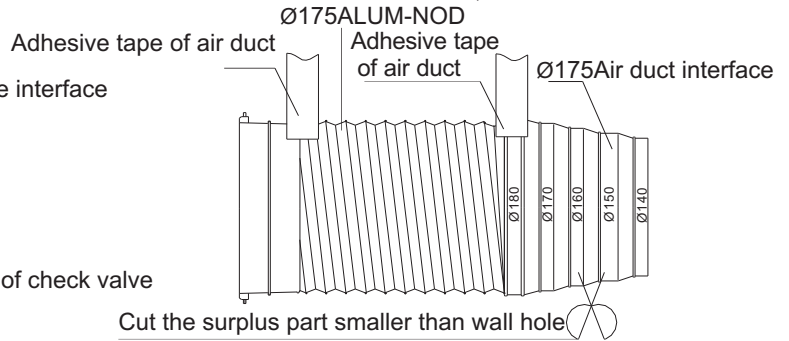
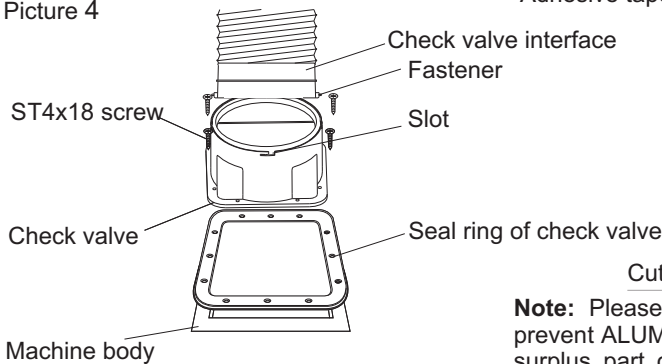

Note: Please straighten the ALUM-NOD while assembling so as to prevent ALUM-NOD from producing noise at semi-stretching state; the surplus part can be cut by wire cutter.

The diameter of exhaust wall hole shall be close to the air duct diameter, which shall not be too small, or it will cause unsmooth fume exhaust, rise of noise and reduction of air volume. Outlet pipe and wall hole or connection with public flue interface must be sealed strictly so as to make sure that the air duct and check valve or public flue interface are connected firmly and make sure that the blade of check valve or public flue interface is flexible in opening and closing.

Use Instruction

Switch Panel

A609 switch panel

A610 switch panel



Lighting



Low speed



High Speed



Power



Lighting



Low speed



High Speed



Power

Range hood should be open before cooking, and connect plug firstly.

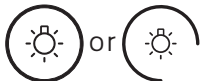

or

Press the "Lighting" key one time, the lighting lamp will be on. Press again, the lighting lamp will be off. This switch just control lighting lamp.



or

Press the "Low speed" when "power" is on, the impeller will rotate in low speed to absorb fume (that is, low speed is turned on). If press "High speed", range hood shall change to high speed.



or

Press the "High speed" when "power" is on, the impeller will rotate in high speed to absorb fume (that is, high speed is turned on). If press "Low speed", range hood shall change to low speed.



or

When "Power" icon is on, if only lighting lamp is on, gently touch the "Power" key, the lighting lamp will be turned off; if "Power" is on and fan is working, gently touch the "Power" key, the power icon will flicker and range hood will be in delayed working condition, then turn off all the working conditions after 1min; if power icon is flickering, gently touch the "Power" key, then all the functions will be shut down.

Maintenance and Services

⚠ Warning

1. There is a fire risk if cleaning is not carried out in accordance with the instructions.
2. Cleaning and maintenance shall be conducted under outage. Electrical components such as motor, switch, and connector shall not be spoiled by water so as to prevent from accidents.
3. It's prohibited to wash with water so as to prevent accidents.
4. Stove fire shall be extinguished timely when it is not used; do not flambe under the range hood and it's prohibited to bake food under range hood directly to prevent range hood from damaging and causing accidents.
5. If the supply cord is damaged, it must be replaced by the manufacturer, its service agent or similarly qualified persons in order to avoid a hazard.
6. Accessible parts may become hot when used with cooking appliances.

Notice

● The hood shall be cleaned and maintained regularly depending on the surroundings, so as to keep its cleanness & efficiency and extend its service life.

We recommend: Clean the surface of hood each time after cooking.

To ensure smooth discharge of fumes, the mesh cover shall be cleaned regularly with warm water and detergent according to actual situations. Be careful to avoid damage.

● Don't use the powerful detergent, we recommend to wipe with wet cloth soaked in neutral detergent and dry it by soft cloth. And avoid detergent to touch switches.

● Don't keep dirt on the surface of range hood for long time.

● Don't use cleaning ball, brush or other harsh tool to clean range hood. It may cause scoring.

● Wear gloves to clean or maintain range hood avoiding from hurt.

● Check oil cup regularly. Hold oil cup by hands as picture,

then remove oil cup and pull out waste oil.

● Don't touch lamp if turn on or turn off in short time. It may cause scald.

● If range hood don't use for long time, pull out the plug. Don't haul plug crudely.

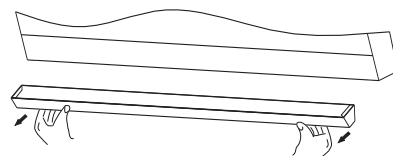

Parts Removal

⚠ Warning

1. The machine body needs not to be disassembled in ordinary conditions. Disassembly shall be operated by professional serviceman.
2. The electricity must be cut off before clean, installation or maintenance of range hood.

Note: The assembly steps are opposite with the disassembly steps.
Please wear protective glove during operation avoiding from hurting hands.

Disassemble interior mesh cover

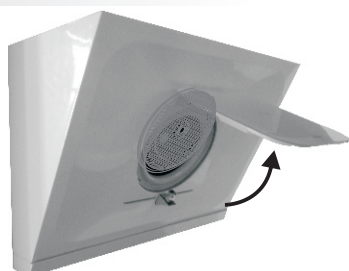

Hold front plate by hands, and revolve it according to arrow direction, make front plate horizontally, and stand front plate by one hand, now, user can disassemble interior mesh cover and clean it.

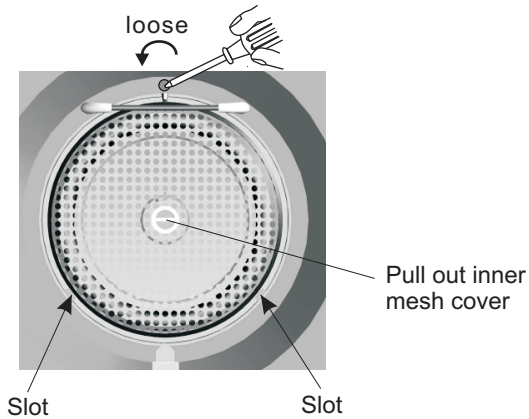

Disassemble Procedure:

1. protective net Rotate the screw in the hole 1-2 cycles counterclockwise by cross screwdriver to loosen pressing plate.
2. Push the pressing plate aside by finger to left or right.
3. Pull out the interior mesh cover.

Note: The assembly steps are opposite with the disassembly steps.

Disassembly and assembly of general drawing

Disassembly procedure:

1. Disconnect the plug;
2. Remove 16pcs of M4 pan head screws and 2pcs of M5 pan head screws on the rear plate, then take out the rear plate;
3. Remove fixed screws on the top of outlet, then take out the air duct;
4. Unscrew the pressing plate to the left or right, and take out the protective mesh;
(See Disassembly of interior mesh enclosure)
5. Unscrew 4pcs of sink head screw on the check ring, then take out the check ring;
6. Screw off the nut cap clockwise to take out impeller vertically;



The machine body needs not to be disassembled in ordinary conditions.
Disassembly shall be operated by professional serviceman.

The assembly steps are opposite with disassembly steps.

(When assembling impeller, please add some lubricating oil in the axle hole of impeller.)

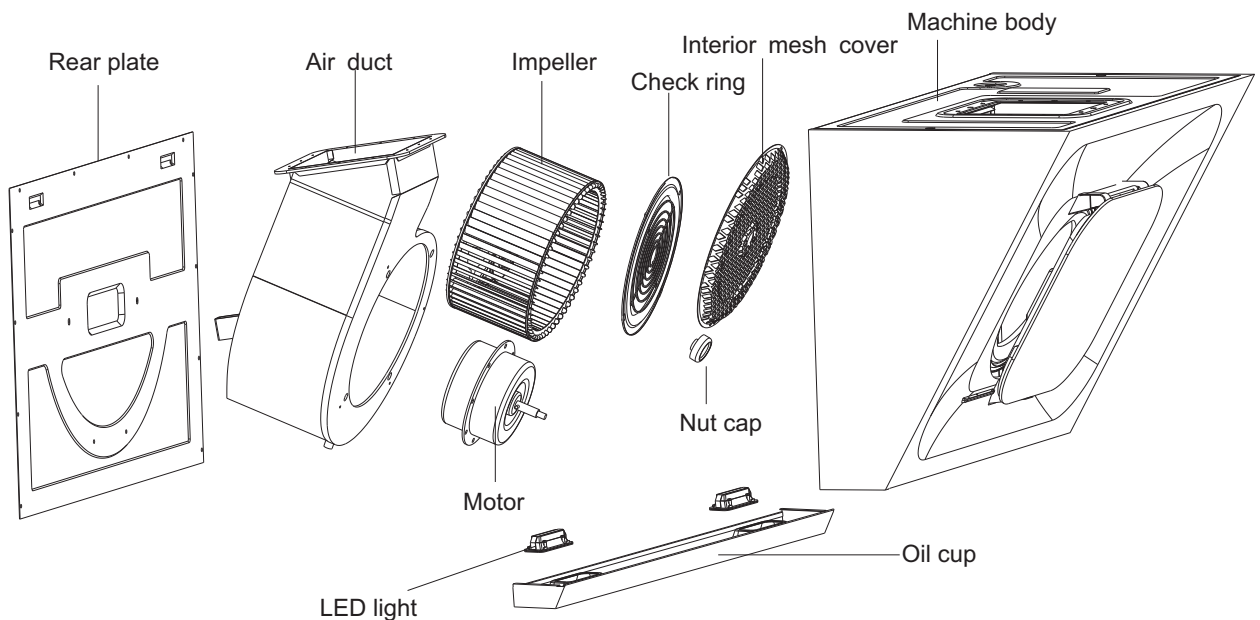

Circuit Diagram

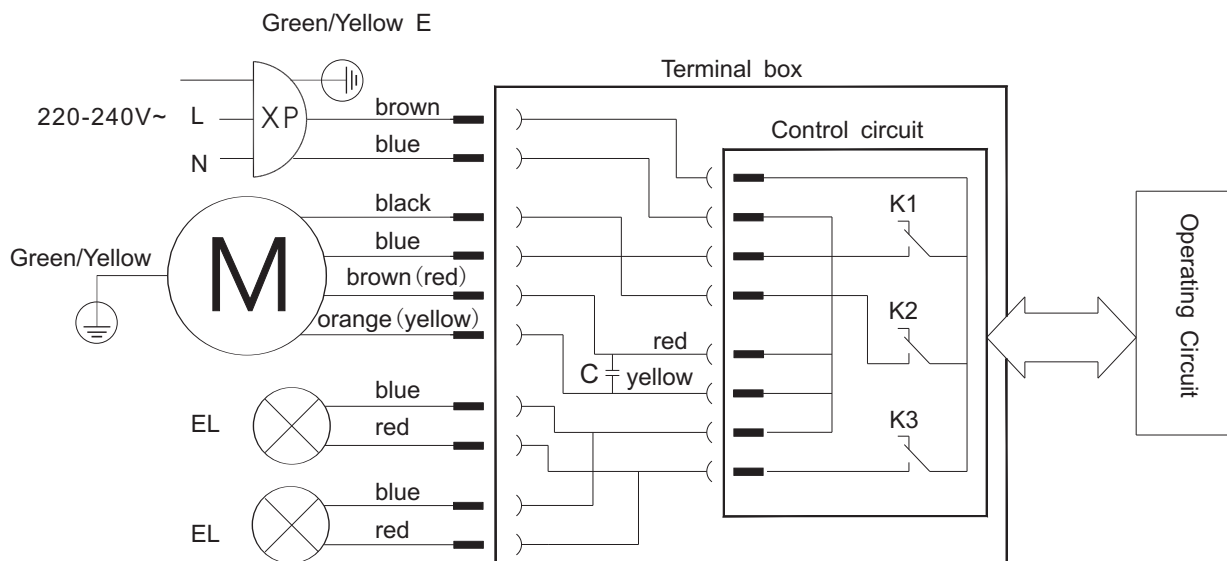

General Troubleshooting

No.	Fault Phenomenon	Fault Cause	Elimination Methods
1	No response by pressing any switch (e.g. impeller does not rotate, lighting lamp is not on)	Power plug is not well connected or power outage	Well connect the power plug
2	Press the lighting switch but the lighting is off	Lighting lamp is broken or power plug is not well connected	Replace lighting lamp or well connect the power plug
3	There is induced electricity on the surface of machine body, hand numbness	Power socket is not well grounded	Use single phase tripolar socket for well ground
4	abnormal sound when impeller is rotating	Impeller is loosened, set screw of impeller is not tightened	Tighten the set screw of impeller
5	abnormal sound for ALUM-NOD	ALUM-NOD is not straightened	Please install according to the requirements of Operation Manual
6	Oil dripping at rear back of hood	Oil cup is not assembled in place after disassembly for cleaning	Assemble the oil cup in place

Model: A609、 A610

Edition: A/2

Publication Date: December,10,2017

ROBAM