

# ROBAM



## User Manual

Before operating this unit, please read the user manual completely and keep it. If the manual is lost, you can send e-mail to [overseas@robam.com](mailto:overseas@robam.com), request for an electronic manual.

## **CXW-260-85H1**

### Range Hood

# CONTENTS

Safety Precaution.....	1
Important Information.....	4
Product Description.....	5
Packing List.....	5
Installation.....	6
User Manual.....	9
Maintenance.....	9
Removal of Components.....	10
Circuit Diagram.....	12
Troubleshooting of General faults.....	12

### Dear users:



Thank for your buying our range hood. Please accept our best regards. Please read this user manual carefully before installation and operation.

\*The pictures in this manual only for your reference. If the picture isn't accord with object, subject to object. We keep to right to update appearance, structure or products without notice.

## Safety Precaution

In order to avoid harm or property damage to the users or other person, the following distinction and marks are stipulated. They are important safety precaution, please comply strictly based on the full understanding.

### Subject to harmful or destruct degree







 Danger	If ignore this sign and operate product improperly, it's highly possible to cause danger, serious injury or fire.
 Warning	If ignore this sign and operate product improperly, it's possible to cause danger, serious injury or fire.
 Notice	If ignore this sign and operate product improperly, it's possible to cause injury or loss.

### Notice and Prohibit Mark



 Prohibit	 Prohibit Flame	 Prohibit Touch	 Prohibit Touch by Wet Hand	 Prohibit Disassembly	 Strict Execution	 Necessary Earthed	 Caution Electric Shock	 Caution Scald
---	--	--	--	--	--	--	--	---

 Warning Please use this product according to manual strictly, or ROBAM shall not take any responsible caused by improper operation.









## Danger

 Prohibit	Don't allow children or weakling to use range hood separately, or it may cause electric shock or other accident.
 Prohibit	Prohibit water on motor, switches or other electric parts; Prohibit wash range hood by water spray. Don't use range hood if wet or it may cause electric leakage or shock.
 Prohibit	Don't change, stretch, bind or press electric wire, or it's possible to cause electric shock or fire because of broken wire.
 Prohibit	Prohibit any change of interior circuit, or it may cause injury or other danger, for example, electric shock or fire.
 Prohibit Touch by Wet Hand	Don't touch plug, electric parts or button by wet hands, or it may cause electric shock.
 Strict Execution	Unplug before cleaning, installing or maintaining, avoiding from electric shock.







 **Danger**

 Strict Execution	Please turn off range hood immediately if pan got fire (range hood shall aggravate fire if it's working) and extinguish fire by effective action. For example, cover flame by metal cover, turn off gas valve immediately and remove inflammable things.
 Strict Execution	Any abnormal, please turn off power, take off plug or cut off electric source, and contact service. It's possible to cause electric shock or fire if using range hood under abnormal situation.



 **Warning**

 Prohibit Disassembly	Range hood must be installed, disassembled or maintained by professional person.
 Prohibit	Stove fire shall be extinguished timely when it is not used; do not flambe under the range hood and it's prohibited to bake food under range hood directly to prevent range hood from damaging and causing accidents.
 Prohibit Touch	Don't touch bulb if it's on or just close in short time, or it may cause scald.
 Strict Execution	In order to ensure safety, range hood must be installed by specific accessory (especially expansion pipe and wooden screws, or it may cause accidental drop of range hood). The pipe bore and hole must fit tightly during the installation of metal expansion pipe. It is prohibited to make excessively large hole to prevent accidental drop of loosening expansion pipe.
 Strict Execution	The range hood must be used by specific plug and properly ground it. It's possible to cause electric shock, hot plug or fire because of improper electric wire. Installation must be executed by professional person based on local electrical regulations. Before connect electricity, power must be turned off.
 Strict Execution	If the supply cord is damaged, it must be replaced by the manufacturer, its service agent or similarly qualified persons in order to avoid a hazard.
 Strict Execution	All operation must comply with our safety guidelines as well as local safety regulations.
 Strict Execution	There shall be adequate ventilation of the room when the range hood is used at the same time as appliances burning gas or other fuels.







## Warning

 <b>Strict Execution</b>	<p>This appliance just for household use only. And it's not allowed to exhaust dangerous or explosive matter or air. It should be put under dry and ventilation environment without dangerous air.</p>
 <b>Strict Execution</b>	<p>The range hood and electric circuit must be installed by skilled and trained personnel with required qualification. When installation, the related regulation, standard or instruction on fire must be complied. It may cause danger because of improper installation, for example, electric shock, drop or fire accident.</p>
 <b>Strict Execution</b>	<p>The outlet must be connect with outside. In order to ensure safety and fresh air, waste gas should be exhaust to outside. Don't exhaust waste gas to the wall, loft or garage.</p>
 <b>Strict Execution</b>	<p>There is a fire risk if cleaning is not carried out in accordance with the instructions.</p>
 <b>Strict Execution</b>	<p>Keep a good habit to turn off gas hob and gas valve if go outside, sleep or finish operation. Replace or check gas pipe regularly, since gas alarm device can't completely avoid accident caused by gas leakage.</p>
 <b>Strict Execution</b>	<p>This appliance is not intended for use by persons (including children) with reduced physical, sensory or mental capabilities, or lack of experience and knowledge, unless they have been given supervision or instruction concerning use of the appliance by a person responsible for their safety. Children should be supervised to ensure that they do not play with the appliance.</p>
 <b>Strict Execution</b>	<p>The minimum distance between the supporting surface for the cooking vessels on the hob and the lowest part of the range hood. When the range hood is located above a gas appliance, this distance shall be at least 650mm. If the instructions for installation for the gas hob specify a greater distance, this has to be taken into account.</p>

## Notice

 <b>Prohibit</b>	<p>The air must not be discharged into a flue that is used for exhausting fumes from appliances burning gas or other fuels, the discharge of air must fulfill the requirements of local regulations.</p>
 <b>Strict Execution</b>	<p>Before removing range hood for installation, clean or maintainance, power must be cut off avoiding from electric shock. When installation, clean or maintainance, protective gloove must be wear avoiding from injury.</p>
 <b>Strict Execution</b>	<p>The temperature for range hood working can't exceed 40°C.</p>

### Notice

 <b>Strict Execution</b>	<p>Because the installation is difficult and hood is heavy, the installation shall be executed by professional person based on manual.</p>
 <b>Strict Execution</b>	<p>Don't break electric wire or other invisible equipment when cutting something or drilling holes on ceiling.</p>
 <b>Strict Execution</b>	<p>When range hood is using in well sealed building, it should have air inlet or open door to ensure good ventilation.</p>
 <b>Strict Execution</b>	<p>When the oil exceeds 2/3 or near tick mark in the oil cup, clean it in time. Don't eat waste oil from oil cup.</p>
 <b>Strict Execution</b>	<p>The wall of installing range hood needs enough strength. For hollow walls, the thickness of solid layer of hollow wall must be more than 30mm, but for concrete walls, it can be drill holes directly. The range hood must be fixed on the wall firmly.</p>
 <b>Strict Execution</b>	<p>Accessible parts may become hot when used with cooking appliances.</p>
	<p><b>DISPOSAL:</b> Do not dispose this product as unsorted municipal waste. Collection of such waste separately for special treatment is necessary. This product must not be disposed together with the domestic waste. This product has to be disposed at an authorized place for recycling of electrical and electronic appliances.</p> <p>By collecting and recycling waste, you help save natural resources, and make sure the product is disposed in an environmental friendly and healthy way.</p>

## Important Information

### Package of Range Hood

Please settle those packages carefully in order to protect environment.

Don't allow children to play plastic film and package, it may cause asphyxia. Please avoid children near package material.

### Before use Range hood

This range hood exhaust fume outside.

Please read this manual and all information carefully before installation and operation. Please comply with our suggestion. If it's necessary, please read manual for gas hob. And please keep these manual carefully for future reference.

If range hood has obvious damage, please don't electrify and contact operator.

## Product Description

### Technical Data

Model	CXW-260-85H1	Rated Power Input	264W
Power Supply	220V-240V~ 50Hz	Rated Main Motor Power Input	260W
Nominal Wind Pressure	270Pa	Dimension (L×W×H)	(895×505×537)mm
Max static pressure	360Pa	Net Weight	20.5kg
Noise	55dB(A)		

Note: 1. The performance test results are all in 230V~ 50Hz power supply environment. The airflow in according to IEC61591-2009, the noise in according to IEC60704.

2. The determined value of nominal wind pressure,max static pressure,airflow shall not be less than 90% of declared value.

3.The noise declared value shown is A weighted sound pressure level.

### Body Size

The marked sizes are for reference only, dimensions in parentheses are the height of the host attached panel.(Unit: mm)

Note: The size inside the cabinet should be larger than the size with \*.

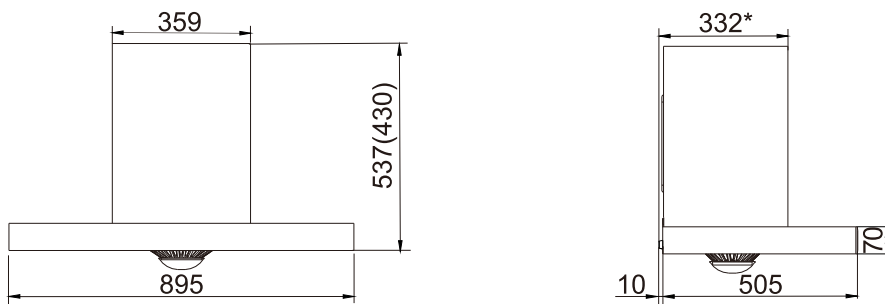

## Packing List

Please check the items in the container upon unpacking

Packing List	No.	Name	Quantity	No.	Name	Quantity
	1	Range hood	1	5	Oil cup	1
	2	Ø185(outer diameter) aluminum exhaust pipe	1	6	Pothook	1
	3	User manual	1	7	Accessory packs	1
	4	Check valve	1			

## Installation

 If the flue aperture is less than air duct aperture, it will influence the fume suction effect and the too long air duct will influence the fume suction effect, too.

### Preparation for installation

#### ●Surrounding

Keep the hood away from too many doors and windows, so as to avoid air convection affecting the efficiency.

#### ●Tools preparation

The hood will be installed with the following tools

1.an impact drill (with drill bit); 2.a wrench; 3.a screwdriver; 4.a ruler.

### Notice

- Installation and circuit setting must be done by experienced professionals. Only a professionally trained person with an installation qualification can install the hood. Non-professionals are not allowed to install, dismantle and repair the hood.
- Please do not power on the hood before installation to avoid electric shock.
- Do not expose the hood if your kitchen is under renovation, because construction materials, dusts, paint, coatings, and emitted gases will corrode and tarnish the hood surface. Therefore, it is recommended to install it after the renovation is completed.
- If you need move the Gas Hob before installing the Range Hood, please close the main valve before moving the Gas Hob.
- Don't install the hood on wood and other combustible walls. The wall shall be made of noncombustible materials with enough strength and the surface shall be flat.
- The hood may have very sharp edges. So, please wear protective gloves during hood installation, cleaning or repair.
- When drilling on the wall or ceiling board, keep away from embedded wires and other concealed devices to avoid electric shock and fire.
- Do not install the hood at a too high position as well as keep the hood free from disturbance of ambient airflow lest the reduction of smoke pumping effect shall occur.
- When making cabinet, please leave space for installation and disassembly of the hood in order to maintain and overhaul the hood.
- When installing, please keep the machine body remain horizontal.
- Please use single phase grounded socket and the hood shall be well grounded (water pipe grounding is not reliable and gas pipeline grounding has risks of causing fire disaster and explosion).
- In order to ensure safety and successful installation, please use standard accessories provided with the hood for installation, otherwise the hood may be at risk of falling down.
- If the power cord is damaged, in order to avoid danger, it must be replaced by manufacturer, professionals of its maintenance department or similar departments. Please do not carry out restructuring, stretching, knotting and squeezing or apply heavy objects to the power cord, etc., otherwise it may cause power cord damage easily, leading to accidents such as electric shock and fire disaster, etc.
- After installation, please clean the surface of the hood, and then supply power for test run.



## Installation

Note: All data units in the following diagram are expressed in mm.

### ● Determine the position

The removable baffle can be adjusted according to the actual situations. The installation pitch of holes is shown in Figure 2. The hood body shall be centered vertically and kept level.

Ceiling hole size is shown in Figure 3. The socket location is recommended to be installed above the ceiling.

**⚠ The hood shall be installed right above the hob. The minimum distance between the supporting surface for the cooking vessels on the hob and the lowest part of the range hood. When the range hood is located above a gas appliance, this distance shall be at least 650mm. If the instructions for installation for the gas hob specify a greater distance, this has to be taken into account.**

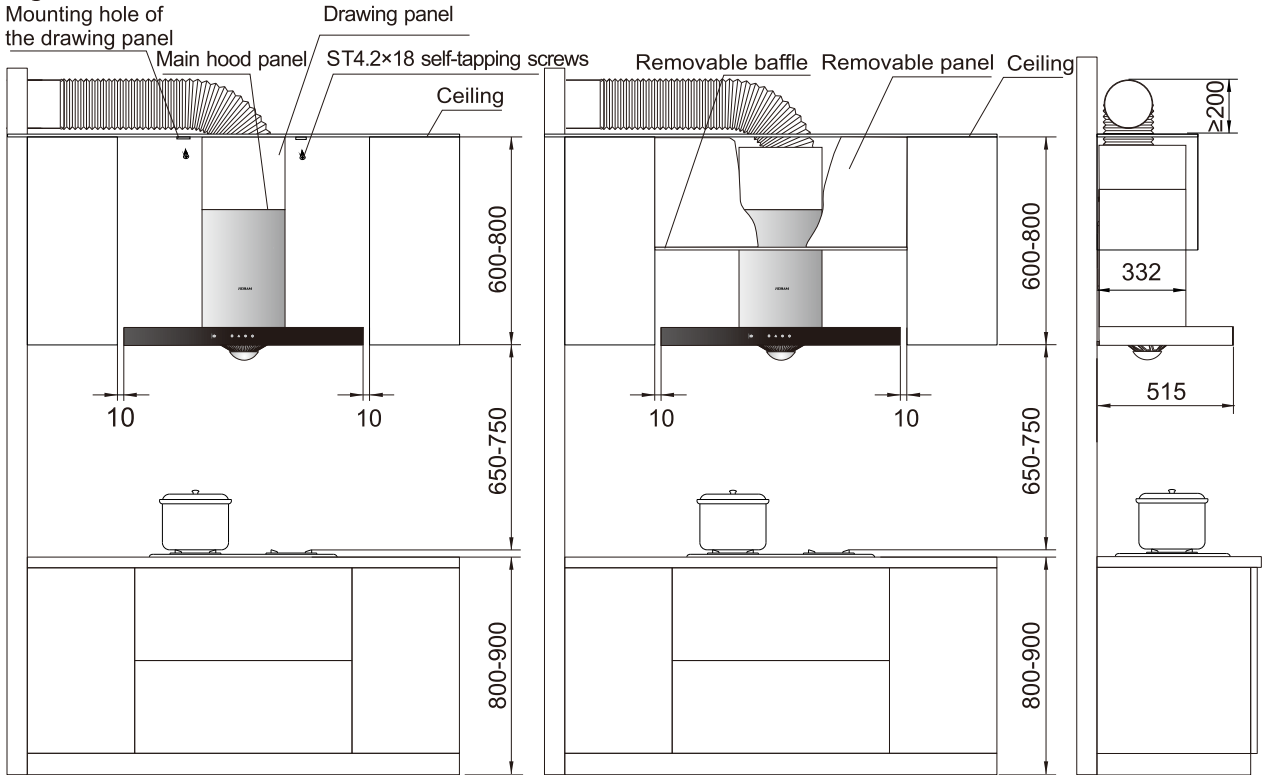

(Figure 1-1 Installation method of hood without removable baffle)

(Figure 1-2 Installation method of hood with removable baffle)

Figure 2

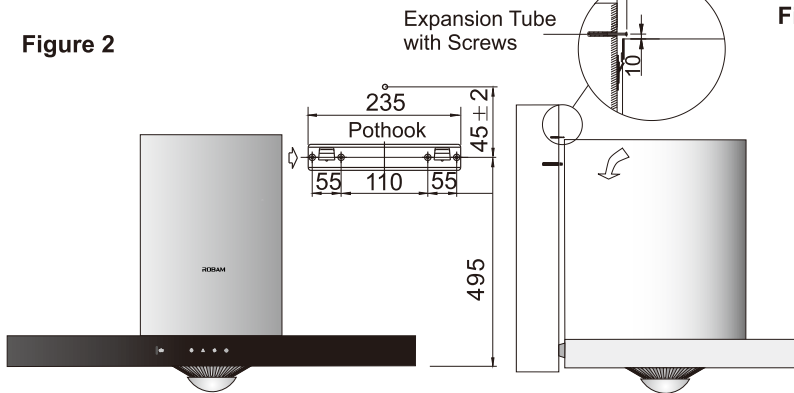

### ● Install pothook

According to the size of the pothook, drill four 60mm-70mm-deep holes on the wall accordingly with an 10mm-diameter drill bit (overlarge holes are prohibited). Press the expansion pipe into the holes, and then fix the pothook with 4 accompanying wood screws. Drill a hole with diameter of 10mm at the position 45mm above the four holes (Figure 2)

Figure 3

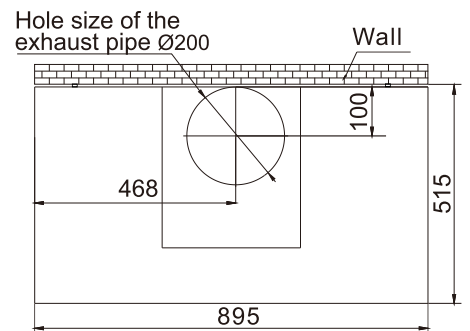

Ceiling hole sizes  
(Projection size of the hood top)

## ● Adjust drawing panel

Pull the two brackets of the drawing panel upwards to an appropriate height and then pull out the drawing panel by holding both sides. Remove the protective film (excluding cold plate materials) on the drawing panel and insert it along the gap between the main hood panel and the housing. Then adjust it to the proper height.

## ● Install hood body

Fix the check valve as shown in Figure 5. Then align the hanging holes in the back of hood with the hooks of pothook according to Figure 2, and press them together. Shake the body to check if it's hung securely. After the body is mounted, install the hitching foot stopper and gaskets to the M6 metal expansion pipe, and then tighten the nuts (to prevent accidental decoupling of the body under external force).

## ● Install drawing panel

As shown in Figure 1-1, there is certain gap between the drawing panel and the top plate. Push the panel against the top plate and then fix it to the top plate with ST4.2×18 screws.

(If installation method in Figure 1-2 is adopted, there's no need to adjust and install the drawing panel)

Note: If there is no host attached panel, no adjustment and installation is required.

## Install the aluminum foil exhaust pipe

### ● Drilling position of the aluminum exhaust pipe (public flues do not require drilling)

a. Aluminum exhaust pipe and hob facing the window: Remove one of the glasses and install a plywood with ventilation holes or punch directly on the glass.

b. Hob away from the window: Install the aluminum exhaust pipe through the window that is close to the hob and connected outside; or install it by punching on the wall that is close to the hob and connected outside.

c. Drill hole through the wall: Determine the location of the aluminum exhaust pipe against the wall and draw the drilling range (i.e. a circle slightly larger than the pipe OD). Then use a long drill bit to drill through the wall. Pay attention to the wall structure and material, so as not to destroy other parts of the wall.

### ● Link the aluminum exhaust pipe

First, straighten the aluminum exhaust pipe, put the end without duct fixing strip on the public flue interface and tape it (if there is no public flue, please pull the duct directly to the outdoor). When the public flue interface or wall hole is larger than the aluminum exhaust pipe, it can be directly connected, when it is smaller than the duct, you can choose the duct interface. First, put one end of the aluminum exhaust pipe without duct fixing strip on the duct interface with tape, and then connect it with the public flue interface. The small end of the duct connector has five specifications: 140mm, 150mm, 160mm, 170mm, and 180mm outside diameter, and the excess part smaller than the public flue connector or wall hole can be cut off according to the actual situation.

Then, put the four clips of the air outlet seat interface into the slots of the air outlet seat and rotate clockwise to fix it. Finally, insert the end of the aluminum foil duct with the duct fixing strip into the outer ring of the air outlet seat interface, fix it with three ST4.2×8 screws in a distribution, and seal it with duct tape.

Figure 4

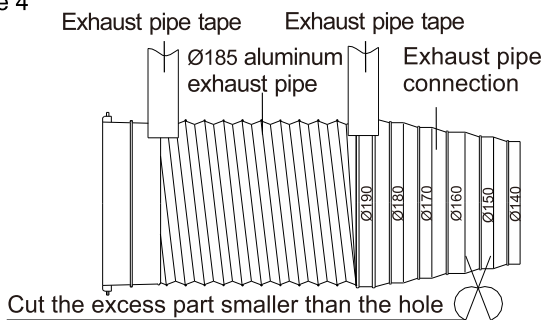
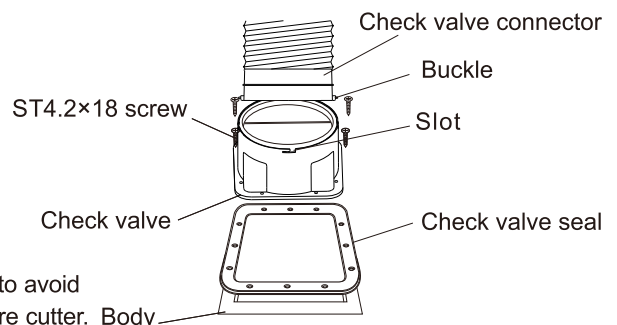

Figure 5



Note: During installation, straighten the aluminum exhaust pipe to avoid noises in semi-stretched state. Excess part may be cut with a wire cutter.



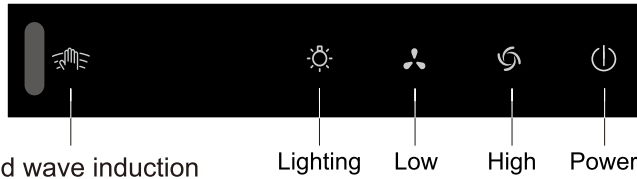

**The exhaust wall hole diameter shall be close to that of the exhaust pipe, which shall not be too small. Otherwise, it will cause poor exhaust efficiency, more noises and lower volume, etc. The connection between the pipe and the hole or the public flue must be sealed tightly to ensure that, the pipe and the check valve or public flue is connected securely. The blades at the public flue connection must be flexible. Recommendation: When the range hood is matched with the anti-smoke back check valve, there is no need to install the range hood with its own check valve blade. If the use of the self-contained air outlet seat blade, in the switching machine may appear blade open and close the sound, is a normal phenomenon.**

## User Manual

### Switch control panel

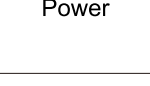

Turn on the power, the buzzer sounds to indicate the power-on state.

 Lighting	<p>Under the power state, press the “Lighting” button once to turn on the lights, and then press it again to turn off the lights. The “Lighting” button only controls the lighting.</p>
 Low	<p>In the power on state, press the “Low” button to run the low function, and the low icon lights up long. Press this button again to turn off the low and the low icon goes off.</p>
 High	<p>When the power is on, press the “High” button to run the high function, and the high icon lights up for a long time. Press this button again to turn off the high and the high icon goes off.</p>
 Power	<p>Press the “Power” button, the power button icon lights up long, the product is in the power on state.</p> <ol style="list-style-type: none"> <li>1.If only the lighting is on, pressing the “Power” button again will directly turn off the lighting.</li> <li>2.If the fan is working, press the “Power” button again, the power button icon will flash and the hood will enter a delayed working state and automatically turn off all functions after 1 minute.</li> <li>3.If the power button icon flashes when the power button is pressed again, all functions will be turned off;</li> <li>4.In the on state, if there is no operation within 3 minutes, it will enter the off state.</li> </ol>
 hand wave induction	<p>If you move within a certain distance area directly in front of the infrared probe, the hood will respond automatically. Under the off state, waving your hand for the first time will automatically turn on the power button; waving your hand again will automatically turn on the strong gear function, and waving your hand under the strong gear state will turn on the weak gear function. In the power off state, long press the strong gear key and weak gear key at the same time, you can turn the induction function on or off. If users are not accustomed to use this function, it is recommended to turn off its infrared function.</p>

## Maintenance

### Notice

- The hood shall be cleaned and maintained regularly depending on the surroundings, so as to keep its cleanness & efficiency and extend its service life.

We recommend that: Clean the outer surface of range hood after each cooking.

To ensure smooth discharge of fumes, the protective screening shall be cleaned regularly according to actual situations. Be careful to avoid damage when cleaning.

- It is recommended to use a neutral detergent to clean instead of strong detergents, and dry with a soft cloth. If your range hood is a mechanical switch, you should also avoid detergent touching each control key.

- Do not allow stains to stay on the surface of the hood for too long.

- Please do not use cleaning balls, brushes and other rough objects to clean the hood to prevent the body surface from scratching.
- When cleaning or maintaining the hood, please wear protective gloves to prevent wounding during wiping.
- Please regularly check and clean the oil cup. When the oil reaches above 2/3 of the cup, rotate the cup rightwards by hand for removal and then pour out the waste oil, as shown in right.
- The range hood shall be started before cooking.
- Please unplug it during long-term shutdown, but please do not pull hard.

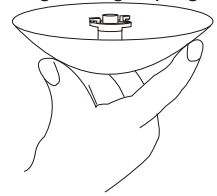

## Removal of Components

Note: The installation procedures of the following components are in reverse with the removal. Please wear protective gloves during operation to prevent the sharp edge of metal hurting your hands.

Before installation or disassembly, the power must be disconnected to avoid electric shock.

### Removal of lamp

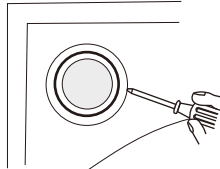

Insert a small flathead screwdriver or something sharp in the gap between the light cover and hood.

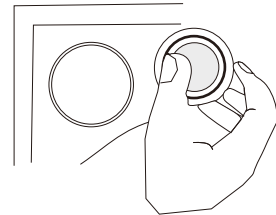

Raise it outward forcibly to remove the spotlight from the hood. Pull out the connector to replace the spotlight.

Lamp image	Lamp information	
	Lamp Type	Round LED
	Max Power	2W×2
	Voltage	12VDC
	Dimension	See the lamp image

### Removal of switch

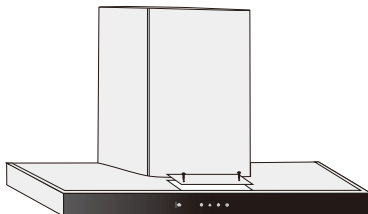

Untighten two screws on the small plate to remove the plate.

**Note: Installation steps of the lights and switches are opposite to the removal steps.**

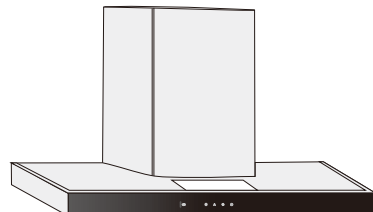

Remove the two screws on the switch cover plate and then rotate the cover plate to pull out the switch assembly for maintenance and replacement.

## Removal of filter



Align the cross screwdriver with the screw hole and raise it upward forcibly meanwhile rotating it counter-clockwise about 120°, so as to remove the screw out of the cross slot of the exhaust fume collecting hood. Hold the bottom of the mesh with one hand, and remove the screw on the other side with the other hand by the cross screwdriver.

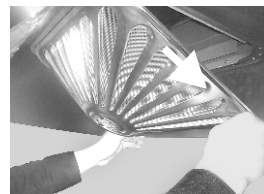

Hold the two screws on the filter mesh with both hands and pull it down to detach the two prongs inside from the filter mesh. Then pull the filter out as per the arrow direction to remove it

Note: When installing the mesh cover, put the side with screw holes inward.

## Removal the whole range hood

Removal steps

1. Pull out the plug;
2. Unscrew the four screws from the back of the main hood panel. Tilt the panel forward to a certain angle, and then pull it up forcibly;
3. Remove the cover plate after screwing down the fastening screw on the cover plate with a Phillips screwdriver.
4. Screw down the fastening screw on the retaining ring and remove the retaining ring.
5. Remove the impeller vertically by screwing down the cap clockwise.
6. Use a cross screwdriver to screw down the fastening screw on the screen cover and take off the oil cup and screen cover.

The assembly procedure is the reverse of the disassembly procedure.

(When putting on the impeller, please put some lubricant in the shaft hole of the impeller.)

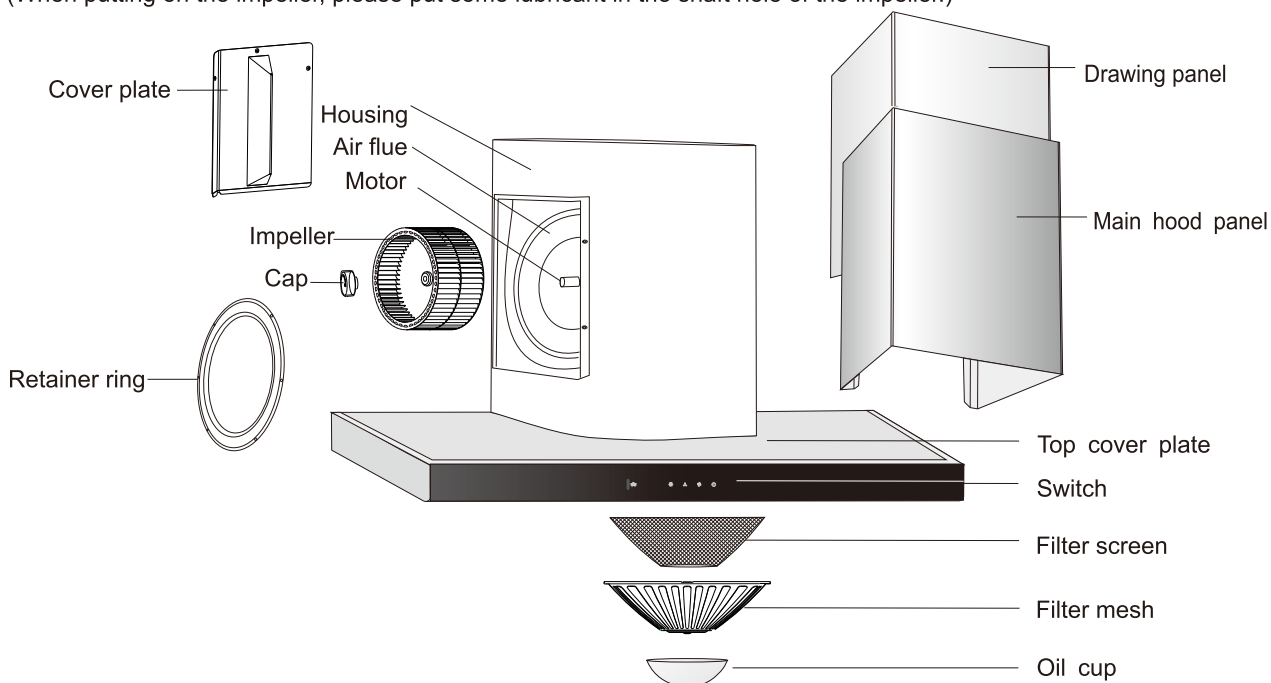

## Circuit Diagram

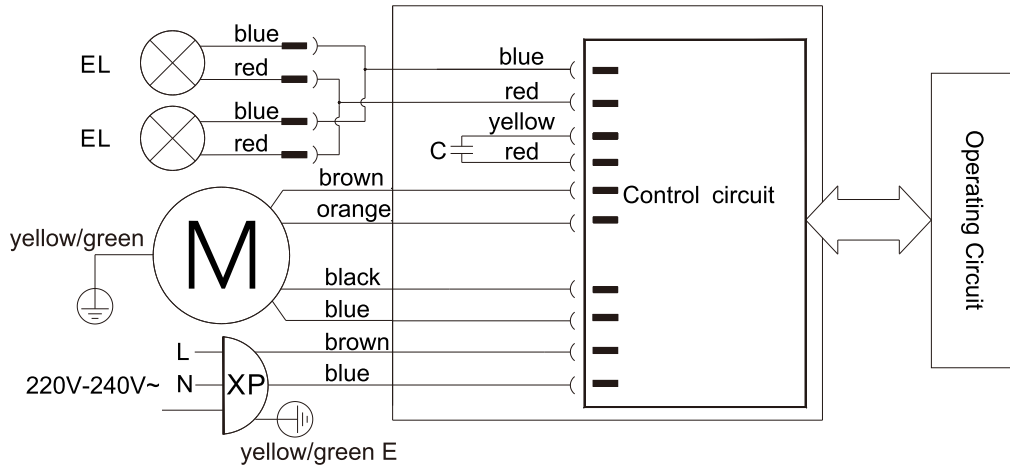

## Troubleshooting of General faults

Fault	Cause	Solution	 Warning
No response after pressing any icon (e. g. the impeller does not rotate, or the light is off)	The power plug is not connected properly or there is power failure	Plug in the power plug	When connecting or replacing the plug, please unplug the power plug.
Pressing the lighting icon, the headlamp is not lit	The light is damaged or poorly connected	Replace the light or plug in the plug	
Induced current exists on the hood body may paralyze hands	The power socket is not grounded well	Use single-phase three-pole socket and well grounded	
Abnormal sound during impeller running	The impeller is loose, and the cap is not tightened	Tighten the cap	
No oil in the oil cup after a period of time	The hood body is tilt	Adjust the body to the horizontal state	

Edition: A/0

Publication Date: November, 5, 2023

**ROBAM**