

ROBAM



Operation Manual

KQWS-2800-R312

Electric Oven



Contents

Safety Precautions	1
Product Introduction	3
Installation Instructions	5
Operation Instructions	6
Common Faults and Fault Dropping	13
Maintenance and care	13
Electrical Schematic Diagram	15









Safety Precautions

In order to avoid any harm or property damage to the users and other persons, following distinctions and signs are specially given. All these are the important notices concerned with safety, so please abide by these notices strictly. And, please use this product correctly on the premise that all the contents herein are understood fully.







Distinctions on contents made in accordance with extent of harm and damage









 Danger	Personal risk, serious injury or a fire may be very likely caused if this sign is neglected and the product is operated improperly.
 Warning	Personal risk, serious injury or a fire may be caused if this sign is neglected and the product is operated improperly.
 Notice	Personal injury or damage to objects may be caused if this sign is neglected and the product is operated improperly.







Signs of the behaviors that shall be paid attention to or that shall be prohibited

 Prohibited	 No open flames	 No touch	 No remove	 Abide by strictly	 To be grounded	 Electric shock danger	 Hot surface
---	---	---	--	--	--	--	--

 **Warning** Please use this product strictly in accordance with contents of this Operation Manual. Our company is not reliable for any property loss or personal injury caused by improper using of this product.

 Danger	
 Abide by strictly Before disconnecting plug from the socket, you should grip the end of the plug. Be sure not to disconnect the plug with power wire in your hand, otherwise such dangers as electric shock, short out and fire may be caused .	 Prohibited Be sure not to use a power socket which is loose or contacted poorly, otherwise such dangers as electric shock, short out and fire may be caused.
 Abide by strictly In order to avoid the electric shock that may occur, please ensure that the appliance has been disconnected from power before replacement of a bulb.	 Abide by strictly The complete appliance shall be kept far away from heat sources and inflammables (e.g. gas and alcohol).
 Hot surface During use the appliance becomes hot. Care should be taken to avoid touching heating elements inside the oven. when taking out foods after using, make sure to wear the high-temperature resistant protective gloves properly in order to avoid burns.	

 Notice	
 Abide by strictly If the supply cord is damaged, it must be replaced by the manufacturer, its service agent or similarly qualified persons in order to avoid a hazard.	 To be grounded Use a separate 16A or higher socket, and be sure not to connect several appliances to the same power socket at the same time, and make sure that the socket is grounded safely and effectively.
 Abide by strictly If the appliance functions improperly, make sure to disconnect it from the power and stop using immediately. And, be sure not to touch the appliance and that it is repaired by a professional.	 Abide by strictly Make sure the power cord is not damaged. When using the power cord, make sure that the cord is not bent, stretched, twisted or knotted. And, Be sure not to press or attack the power cord with weight.
 Abide by strictly You should cut off the power before cleaning of the appliance and use a neutral detergent to clean it. Moreover, make sure to clean it with a soft piece of cloth, in order to prevent its surface from being scratched.	 Abide by strictly Make sure to disconnect the electric oven from power before removing the fan guard. After cleaning, reset the guard properly to the original position in accordance with the Operation Manual.
 Abide by strictly Turn off the appliance immediately after using, otherwise the residual fat may cause a fire; in case the appliance is not to be used for an extended period of time, please cut off the power.	 Abide by strictly Hot air may come out when door of the appliance is opened after using, so please be sure not to stand too close to the appliance to avoid burns caused by the hot air.
 Abide by strictly WARNING: Accessible parts may become hot during use. Young children should be kept away.	 Abide by strictly WARNING: Ensure that the appliance is switched off before replacing the lamp to avoid the possibility of electric shock.
 Prohibited Do not use harsh abrasive cleaners or sharp metal scrapers to clean the oven door glass, since they can scratch the surface, which may result in shattering of the glass.	 Prohibited Never place any flammable substance (e.g. smoke agent) in or under the appliance; when using the appliance, be sure not to spray any smoke agent around it and that the appliance is always supervised.
 Abide by strictly In order to prevent a fire, the appliance should be kept clean and the air duct should be kept smooth.	 Abide by strictly Be sure not to operate the appliance when any of your hand or foot is wet or your feet are bare.
 Prohibited This appliance is not intended for use by persons (including children) with reduced physical, sensory or mental capabilities, or lack of experience and knowledge, unless they have been given supervision or instruction concerning use of the appliance by a person responsible for their safety. Children should be supervised to ensure that they do not play with the appliance.	

 Notice	
 Abide by strictly If the appliance functions abnormally, please disconnect the power plug and power it on again.	 Abide by strictly The internal grills and ovenware, etc. should be placed properly during using.
 Prohibited Be sure not to use a steam cleaner.	 Prohibited The appliance cannot be used as an indoor heater.
 Abide by strictly Use a temperature sensor recommended for this electric oven.	

Product introduction

Dear users:

We take this opportunity to express our heartfelt thanks to you for your choosing of ROBAM brand electric oven series products. We especially recommend that you shall read this Manual carefully before installing and using this product and keep it properly for later reference.

Our company is a professional corporation specializing in production of household appliances and kitchen wares such as extractor hoods, electric ovens, gas cookers and disinfectant cabinets in China. The electric oven of ROBAM brand adopts advanced design concept and optimized molding and focuses on matching with cabinet in the aspect of overall design.

Important Information

Packaging of electric oven

Please dispose these packaging materials in an environment-friendly way, in order to keep a good environment.

Be sure not to allow children to play with the packaging materials (e.g. plastic film and carton box, etc.), otherwise it would lead to suffocation accident. So, please keep children away from the packaging materials.

Product Characteristics

- The intelligent one-button menu makes operation more convenient and makes baked foods taste better;
- The built-in full-automatic precise temperature control probe of the product adopts dual-temperature dual-control technology, which improves baking quality of foods;
- The high-temperature enamel liner is durable and the roll-over heating tubes are convenient for removal and easy for cleaning;
- The integration of special hinges and multi-layer tempered glass door makes opening/closing of the door easy and flexible;
- The multi-function baking options meet multiple baking demands and are easy to be operated;
- The professional baking modes and independent upper/lower temperature control which are provided specially meet diversification and taste of baking;
- The high-quality heating tubes for baking are characterized by rapid temperature rise, high heating efficiency and long service life;
- The energy-saving, environment-friendly and high temperature-resistant super cotton has good thermal insulation properties and saves power energy during baking;
- The rotating bake function which is provided specially meets variety of demands of baking;
- The self-cleaning fan cover plate absorbs oil stains at decomposing surface automatically and reduces cleaning difficulty of users.

Technical Parameters of the Product

Item No.	KQWS-2800-R312
Rated Voltage	220-240V~
Rated Frequency	50Hz
Rated Power	2800W
Capacity	60L
Net Weight	41kg
Dimensions W × H × D(mm)	595 × 595 × 520

ROBAM | Electric Oven

Product Structure

(The picture is for reference only, specifications are subject to the physical product)

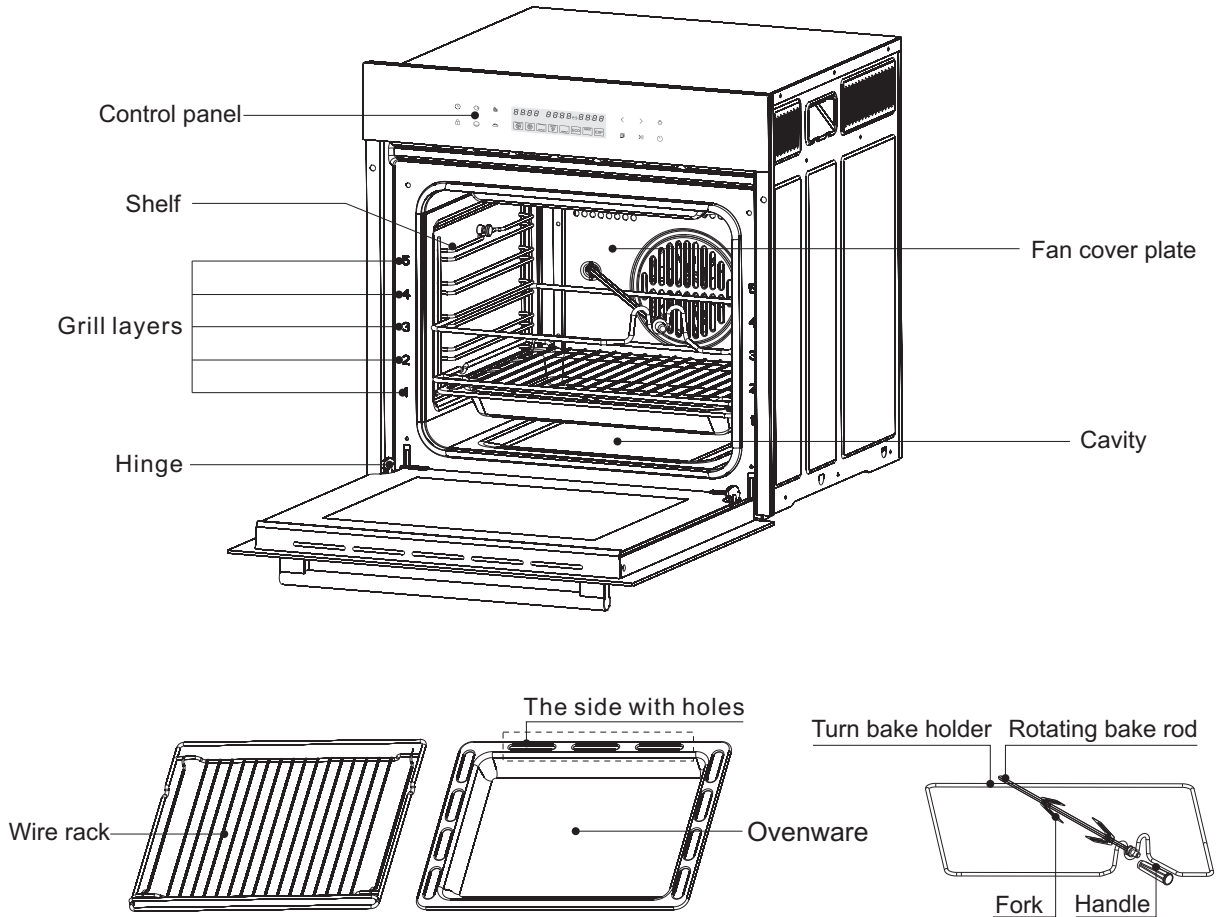

Note: when placing the ovenware, the side with holes shall be placed inward.
The Wire rack should be placed in the Shelf.

List of Accessories

S/N	Name	Quantity
1	Operation Manual	1copy
2	Wire rack	1copy
3	Ovenware	1copy
4	Fork component	1suit
5	Turn bake holder	1copy
6	Shelf	2copy
7	Mounting screw	2copy

Installation Instructions

Drill a square hole on the setting position of the cabinet according to the installation drawing as shown below, insert the electric oven into this square hole stably and keep the electric oven horizontal. The specific dimensions of the hole are as shown in following table:

S/N	Name	A	B	C
1	Dimensions of the hole for full insertion	600	600	565
2	Dimensions of the hole for semi-insertion	560	590	550

(The pictures are for reference only and the specifications are subject to the physical product)

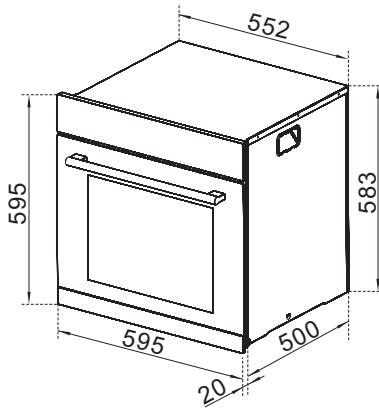

Complete dimensions diagram

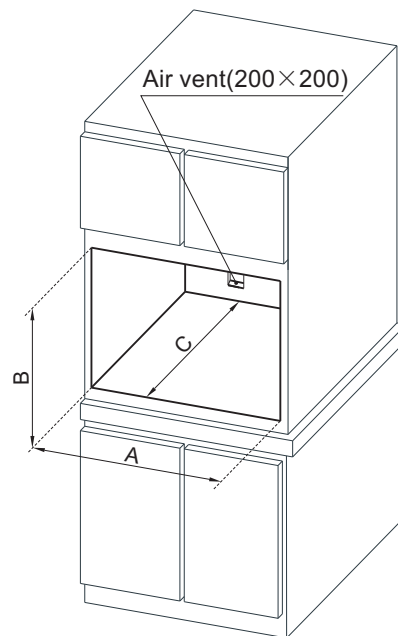

Semi-insertion hole diagram

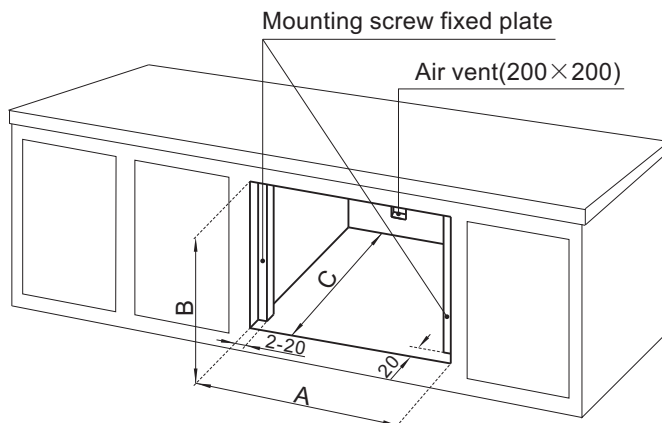

Full insertion hole diagram

Installation Requirements:

The oven must not be installed behind a decorative door in order to avoid overheating.

The surface where the electric oven is to be placed on should be flat and the air around the electric oven mounted in the cabinet shall be ventilated well as much as possible. It is recommended that the clamping plates and fixed plates shall adopt incombustible thermal insulation material.

For easy connection and disconnection of power cord, be sure to disconnect the power supply at any time after the installation of the oven. a separate 16A or higher socket shall be used, be sure not to connect several appliances to the same power socket at the same time, and that the socket is grounded safely and effectively. In case there is any other electrical appliances around, please keep a 100mm or larger mounting distance.

Operation Instructions

Introduction to Control Panel

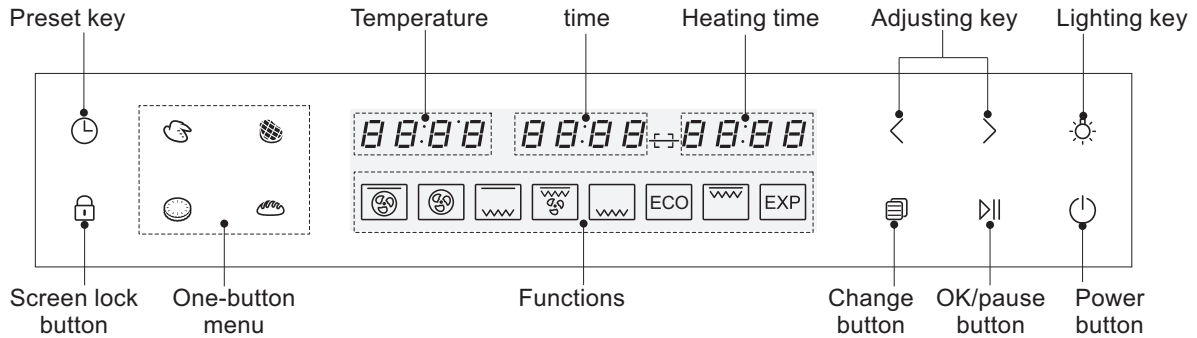

Operation Instructions

- During first use of the electric oven, there may be some peculiar smells caused by evaporation of the heated coating because heating elements of the electric oven are protected with coating during storage. Therefore, it is recommended that the room be kept open for ventilation before using of the oven, after which select the “Fan baking” function, and set to the highest temperature and the longest operating time for heating to remove peculiar smell of the coating without foods, then open the door of the electric oven after operation to cool it down, in order to ensure deliciousness of subsequent baking.
- “Turn bake” mode: insert foods to rotating bake rod and secure the foods with forks, then place rotating bake rod on turn bake holder and the turn bake holder on the third shelf, and push it into the electric oven, then insert rotating bake rod into the transmission shaft of turn bake motor smoothly when the holder approaches to rear part of the cavity, and rotate handle of the rotating bake rod anticlockwise after the rod is arranged in place. Then, this mode can be carried out.
- When the “Rotating bake” mode is successfully carried out, rotate handle of the rotating bake rod clockwise so that it can be rotated into the rotating bake rod, then move the rotating bake rod axially while pulling out the turn bake holder so that the rotating bake holder can be taken out smoothly; when pulling out the turn bake holder, pay attention that the accessories (e.g. turn bake holder) are hot, so be sure not to touch them with hands directly to avoid burns.
- After the power is cut off, the fan will not shut down immediately in that the temperature of inner elements of the appliance is too high. However, This is favorable for extension of service life of the appliance.

Warm tip: it is recommended that you should open the extractor hood when using the electric oven.

Using Methods

1. Power on

After the power source is connected, a beep sound will be made and all the indicator lights will turn on (as shown below). After several seconds, the display screen will display “12:00”, the “⌚” button will blink, other indicator lights will turn off and the appliance will be ready. If no operation is carried out within approximately 3 minutes, the appliance will turn off.



2. Time adjustment

When the display screen displays time ("12:00" in default), press and hold the "⌚" button and the "Hour" of the time will blink, then press "<" or ">" to adjust the hour. And, press the "⌚" button again so that the "Minute" of the time will blink, then press "<" or ">" to adjust the minute. The adjustment will be set automatically after several seconds, or you also can set directly by pressing the "▶||" button. The time will turn off automatically several minutes after the appliance is turned off.

Note: the time will restore to the default value "12:00" automatically after the power is cut off and shall be readjusted after power on.

3. Starting up

Press and hold the "⏻" button to start up, then the "Rapid heating" mode will be set, as a result, the icons "⊕" and "▶||" will blink and are adjustable (as shown below);



4. Selection of functions

Press "<" or ">" button to select the desirable baking function, and the selected functional icon will blink (e.g. select "Wind baking", as shown blow), and the display screen will display default temperature and time.



Press "⊕" button to switch to "Temperature", and the "Temperature" will blink. Then, press "<" or ">" button to adjust baking temperature (as shown below).



Press "⊕" button to switch to "Time", and the "Time" will blink. Then, press "<" or ">" button to adjust baking time (as shown below).

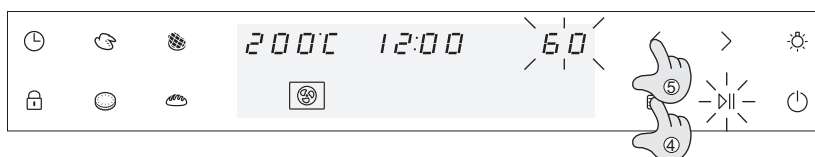

Note:

- If it is unnecessary to adjust the temperature and time, press the "▶||" button to start directly after selection of function.
- When adjusting the baking temperature and time, users can adjust the temperature and time in accordance with the baking reference table or personal taste and cooking experience of their own.
- Blinking will continue until the "▶||" button is pressed.
- The "Temperature", "Heating time" and "Functions" will realize automatic switch when the "⊕" button is pressed.

Press and hold "<" or ">" button so that the temperature or time can increase or decrease progressively.

5. Confirmation to start up

After the function is set, press “▷||” button to start up (as shown below); then, the electric oven will enter into preheating mode automatically and makes a beep sound when the preset temperature is reached. At this time, place the foods into electric oven and the buzzer will beep after baking is completed.



Note: ● During operation, you can press the “▷||” button to stop.

- Pay close attention in baking process so as to readjust the time and temperature or stop baking when necessary, in order to avoid bad baking effect.
- In order to obtain better baking effect, it is recommended to place foods into electric oven only after the oven is preheated.

■ Adjustment of settings

During baking of the electric oven, if you want to change the set baking mode, temperature or time, please press the “▷||” button to stop baking so that the oven is in adjustable status, then reset the mode, temperature and time. After adjustment, press the “▷||” button again to enter into the baking mode. (In case that the screen is locked, cancel screen lock button “🔒” first and then press the “▷||” button again to stop operation for adjustment.)

■ Expert baking mode

In order to meet diversified baking and taste of customers, the expert baking mode is especially set. This function can realize automatic control of heating temperature of the oven’s upper and lower layer. The operation procedures are as follows:

1. First select the “EXP” expert baking mode;
2. Press “☰” button to set temperature of upper layer, and the display screen will display “88.88”, then press “<” or “>” button to adjust temperature;
3. Press “☷” button to set temperature of lower layer, and the display screen will display “88.88”, then press “<” or “>” button to adjust temperature;
4. Press “☰” button to set baking time and press “<” or “>” button to adjust time;
5. Finally, press “▷||” button to start and a beep will be made when the preset temperature is achieved. Then, place foods into the electric oven. After baking is completed, the buzzer will beep.

Note: the temperature difference between the upper and lower layer can be up to 30℃; In the baking process, the temperature of the upper and lower layer will be displayed in turn.

■ Rotating bake settings

1. If you want to use the rotating bake mode, press and hold the icon “☰” after the oven enters into the baking state (except the EXP state), at this moment, the display screen will display the rotating bake icon “☰” , then the rotating bake mode is successfully set;
2. If you want to cancel the rotating bake mode, press and hold the icon “☰” , at this moment, the rotating bake icon “☰” on display screen will turn off, then the rotating bake mode is successfully canceled.

Note: The rotating bake function cannot be used in EXP state.

■ One-button menu

In order to make it convenient for customers to operate fast, a one-button menu including “Chicken wing 🍗, beef 🍖, biscuit 🍪 and bread 🍞” is especially provided. Press the desired menu button directly and press the “▷||” button to start, at this moment, the display screen will display real-time temperature and countdown time (as shown below). A beep will be made when the preset temperature is achieved. At this moment, place foods into the electric oven. After baking is completed, the buzzer will beep.

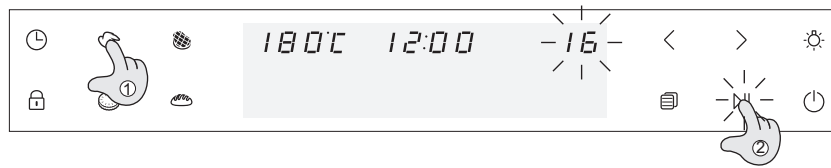

Note: The customers may press “<” or “>” button to adjust baking time after selecting the menu in accordance with weight or thickness of foods.

※ In order to ensure the delicacy of baked food, we specially provide the (**recipes and preparation methods**, for reference only) for the one-button menu. The customers may also adjust by themselves in accordance with their own cooking experience and taste.

Recipes and Preparation Methods

Baked chicken wings

Ingredients: 300g chicken wings (approximately 10), 50g New Orleans seasoning, 10g honey and 10g salad oil.

Preparation method:

1. Slightly cut two times at a tilt at each side of the chicken wing, so that the wings to be soused are tastier;
2. Sousing: have the chicken wings soused with the mixture of New Orleans seasoning, honey and salad oil for more than 2 hours;
3. Place the soused chicken wings on an ovenware lined with tinfoil and then brush a layer of honey to surface of the chicken wings;
4. Select the “👉” button and start, and a beep will be made when the pre-heating temperature is reached. Place foods to the third layer of the electric oven for automatic baking.

Baked chicken wings

Ingredients: 300g chicken wings (approximately 10), 50g New Orleans seasoning, 10g honey and 10g salad oil.

Preparation method:

1. Slightly cut two times at a tilt at each side of the chicken wing, so that the wings to be soused are tastier;
2. Sousing: have the chicken wings soused with the mixture of New Orleans seasoning, honey and salad oil for more than 2 hours;
3. Place the soused chicken wings on an ovenware lined with tinfoil and then brush a layer of honey to surface of the chicken wings;
4. Select the “🌐” button and start, and a beep will be made when the pre-heating temperature is reached. Place foods to the third layer of the electric oven for automatic baking.

Cranberry biscuits

Ingredients: 115g low-gluten flour, 75g butter, 1g salt, 60g powdered sugar, 15ml egg cream and 25g dried cranberry.

Preparation method:

1. Beat the softened butter well with an eggbeater, and add powdered sugar into the butter and mix them evenly in three times until the mixture appears creamy white;
2. Add egg cream into the mixture and mix them evenly in several times (be sure not to beat it to leaven);
3. Add the screened low-gluten flour into the mixture and mix them evenly until the flour cannot be seen;
4. Add the chopped dried cranberries into the mixture (be sure not to crush the cranberries), then knead the mixture into a dough and cover it with a piece of plastic wrap, and then form the dough into a rectangle by hands or a mold and put it into the refrigerator for freezing (for approximately 1 hour. Warm tip: please place it into the freezer, rather than the cooler!);
5. Take out the frozen dough, remove the plastic wrap and cut it into pieces (about 4mm thick) with a knife as quickly as possible. In order to prevent these pieces from being softened, place them in the ovenware immediately after cutting;
6. Select the “🍪” button and start, and a beep will be made when the pre-heating temperature is reached. Place foods to the third layer of the electric oven for automatic baking.

Warm hint: During baking, pay attention to observe surface color of biscuits. The baked biscuits will have intense flavors!

Cream buns

Ingredients: 400g high-gluten flour, 120g powdered sugar, 200g unsalted butter, 2g salt, 50g egg, 60g milk, 40g butter and 6g yeast powder.

Bottom seasoning: 5g flour, 10g black sesame and 10g powdered sugar.



Preparation method:



1. Kneading of dough: add all ingredients except butter into the break maker and mix them for 20 minutes (the milk can be added in several times according to conditions of the dough) until the dough looks smooth slightly. Then, add the softened butter to the dough and mix them for 20 minutes until slight transparent film can be dragged out from the dough;
2. Fermentation: when the dough is leaven to 2-2.5 times of its original size, take it out and divide it into small dough (of 30g each). Round these dough and cover them with a piece of plastic wrap, then make them stand for 15 minutes. Then, round the dough again, coat bottom of them with the mixed bottom seasoning, and place them on the ovenware that has been lined with a piece of oil paper to make them leaven to 2 times of their original size;
3. After these dough are leaven to 2 times of their original size, brush egg liquid on them;
4. Select the “” button and start, and a beep will be made when the pre-heating temperature is reached. Place foods to the third layer of the electric oven for automatic baking.

Note: the fermentation can be completed by placing the dough into a fermentation room or oven (when an oven is used, it is recommended to place a pot of hot water, in order to keep certain moisture and temperature).

■ Preset function



For example: if the preset time is 9:00 a.m. but the customer wants to start baking at 10:30 a.m., the specific operations are as follows:



1. Select the baking function first and then press the “” button to preset, thereafter the “Hour” will be adjustable. Press “<” or “>” to adjust the “Hour” until “10” is displayed;
2. Press the “” button again, and the “Minute” will be adjustable. Press “<” or “>” to adjust the “Minute” until “30” is displayed;
3. Press the “” button to start preset function, at this moment, the icon of preset menu will blink;
4. The appliance will enter into baking mode automatically when the time displayed on the display screen reaches to “10:30”.

- Hints:**
- The preset function will be realized when “” button is pressed. If this button is pressed repeatedly, “Hour” and “Minute” adjustment will be switched in turn;
 - If you want to cancel the preset function, please press and hold the “” button;
 - The preset time refers to the time that baking starts;
 - Before using the preset function, please make sure that the time displayed on the product is correct.

■ Screen lock function

This function refers to screen lock when the electric oven is working, which can effectively prevent improper operations of children or other persons:

1. In this working mode, press the “” button, and the corresponding indicator light will turn on, then the appliance will enter into program lock state;
2. If you want to cancel the lock state, press and hold the “” button, then the screen lock mode will be canceled.

Note: the “” and “” buttons will not be locked; if you press and hold the “” button in screen lock mode, the appliance will turn off.





■ Lighting function

In power-up state, the lighting function will be started when you press the “” button. When you press this button again, the lighting function will be disabled. If you do not press this button for one minute, it will turn off automatically.

■ Power off

1. The buzzer will beep after baking process of the electric oven ends, which shows that the heating is stopped and the oven is powered off;
2. When the electric oven is in stand-by state (state of no operations), the oven will power off after several minutes.
3. During the baking process, if you press and hold the “” button, the oven will stop heating directly and turn to power-off state.

Baking Reference Table

Function	Food	Position of Grill	Apparatus Adopted	Temperature (°C)	Baking Time (min)	Remarks
 Rapid heating	Corn	3	Wire rack	220-230	35-45	
	Vegetables	3	Wire rack	180-190	15-20	
	Egg tart	3	Ovenware	200-220	16-23	
 Wind baking	French chips	3	Ovenware	175-185	15-25	
	Sweet potato	3	Wire rack	220-230	45-60	About 200-300g/each
 Baking	Cup cake	3	Ovenware	170-180	20-25	
	Cake	3	Stainless steel cookware	155-165	45-55	Applicable for 8 in. cake
	Bun	3	Ovenware	165-175	15-20	About 30g/each
	Biscuit	3	Ovenware	160-170	15-22	About 3-4mm thick/piece
	Pizza	3	Ovenware	190-210	15-20	Applicable for 8in. and 9in. pizza
 Fan baking	Pork chop	3	Ovenware	190-205	18-23	About 9-12 thick/piece
	Streaky pork	3	Ovenware	210-230	25-35	The whole piece of streaky pork is 300g weight (the recommended dimensions are approximately 150x50x50mm (L x W x T))
	Bacon	3	Ovenware	195-205	7-12	About 2mm thick/piece
	Wing middle joint	3	Wire rack	180-200	15-20	About 25-35g/each
	Drumstick	3	Wire rack	195-215	20-30	About 60g/each
	Roast duck	3	Wire rack	200-220	45-60	About 1,600-1,800g/piece
	Roast chicken	3	Wire rack	200-220	35-50	About 900-1,400g/piece
	Shrimp	3	Wire rack	180-200	8-12	
Steak	3	Wire rack	180-200	10-15	About 12-14mm thick/piece	
 Strong grill	Steak	3	Ovenware	180-200	10-15	About 12-14mm/piece
	Sausage	3	Wire rack	185-195	15-20	
	Bacon	3	Ovenware	180-200	8-13	About 2mm thick/piece
	Roast chicken	3	Wire rack	195-215	50-65	About 900-1,400g/each
	Wing middle joint	3	Wire rack	180-200	15-25	About 25-35g/each
	Wing root	3	Wire rack	190-210	20-30	About 50g/each
	Drumstick	3	Wire rack	200-220	25-35	About 50g/each
	Roast fish	3	Ovenware	195-210	25-30	About 500g/piece

Notes:

- The baking temperature and time of foods mentioned in above table are for reference only. During baking of foods, users can adjust the baking temperature, time, baking function and baking layer according to their own tastes and baking experience;
- When baking meats of larger size (e.g. chicken and duck, etc.), the taste will be better if you have it baked at low temperature first and then bake it at high temperature thereafter;
- Before baking of foods requiring to be soured, users can have the foods soured with the prepared ingredients for approximately 30-40 minutes. Then, the foods will be tastier;
- Users also can bake the same food with different functions according to their own baking experience;
- In order to ensure that the heating is even during baking, it is recommended to turn foods over during baking. Especially, the chicken or duck should be turned over during baking.

Baking & Heating Modes

Function	Default Temperature (°C)	Default Time (min)	Upper Outer Heating Tubes	Upper Inner Heating Tubes	Bottom Heating Tubes	Rear Heating Tubes	Rear Fan	Lighting	Rotating Baking Motor	Cooling Fan
Rapid heating	200	50	●			●	●	○	○	◎
Wind baking	200	60				●	●	○	○	◎
Baking	160	60	●		●			○	○	◎
Fan baking	220	60	●	●			●	○	○	◎
Bottom heating	160	50			●			○	○	◎
ECO	180	50		●				○	○	◎
Strong grill	180	40	●	●				○	○	◎
Expert baking	Upper 160 Lower 130	20		●	●			○		◎
Chicken wing	The modes and temperature will be changed and controlled automatically							○		◎
Beef								○		◎
Biscuit								○		◎
Bread								○		◎

Note: users can know the heating ways and select an appropriate baking function according to the heating modes mentioned in this table. ● Required ○ Optional ◎ Subject to temperature control

Common Baking Symptoms and Remedies

Symptoms	Possible Causes	Remedies
Baking is uneven	<ul style="list-style-type: none"> * Position of the baking layer is incorrect * Foods are not placed at center part of the ovenware * Selected function is improper 	<ul style="list-style-type: none"> * Select an appropriate baking layer position * Place foods at center part of the ovenware * Select a proper function
Upper surface color or bottom color of the baked foods is dark	<ul style="list-style-type: none"> * Selected function is improper * Size of foods is non-uniform or foods are not arranged evenly * Baking temperature is too high * Door of the electric oven is opened frequently during baking 	<ul style="list-style-type: none"> * Select a proper function * Cut foods into uniform pieces and arrange them evenly on the ovenware * Lower the temperature * Place the foods to a lower or higher position * Only open door of the electric oven when half of the baking time elapses
The baked cake has cracks or thick crust	<ul style="list-style-type: none"> * The baking time is too long * Baking temperature is too high * Bake recipe or preparation method is incorrect * Selected container is improper 	<ul style="list-style-type: none"> * Adjust the baking time * Lower the temperature * Adjust recipe and adopt correct preparation methods * Replace with a proper container
The baked foods are light-colored or under-baked	<ul style="list-style-type: none"> * Baking temperature is too low * Baking time is too short 	<ul style="list-style-type: none"> * Adjust the baking temperature * Extend the baking time

Common Faults and Fault Dropping

Faults	Possible Causes	Fault Dropping
The electric oven does not work	* The power is not switched on * Functional button is not operated properly	* Switch on the power * Operate properly
Lighting lamp of electric oven does not light up	* The bulb is burnout * Wire harness of bulb is off or disconnected	* Replace the bulb * Contact with the professional maintenance personnel
Temperature rise of electric oven is not enough	* Heating tube is off * Sensor fails	* Contact with the professional maintenance personnel
Smoke comes out from electric oven at first use	* The protective oil is being evaporated	* Wipe it out with a piece of cloth
<i>E-03</i> is displayed on display screen	* Temperature protection fails	* Contact with the professional maintenance personnel
<i>E-05</i> is displayed on display screen	* Sensor fails	* Contact with the professional maintenance personnel
<i>E-06</i> is displayed on display screen	* Communication fails	* Contact with the professional maintenance personnel
The solid electric heating tube fades in color	* Color fading of heating elements and decorative rings during heating is normal	* This is a normal phenomenon and shall not be treated

Note:

please contact with authorized service center or dealers of our company when any of the fault still lasts after fault dropping, and never allow any non-specialized person to remove or install the appliance without authorization.

Maintenance and care

Important Notification: before cleaning the electric oven, make sure to cut off power of the electric oven first and never clean with steam.

Always keep the electric oven clean and make sure that no grease and oil is accumulated around the heating elements and fan; the ovenware and wire rack, etc. should be cleaned up, in order to prevent a fire from being caused by accumulated grease; before baking of meats, wrap the meats with a piece of aluminum foil in order to make it convenient for later cleaning; all the greases and oils will form a layer of lacquer deposit which is difficult to be cleaned in the electric oven. Therefore, the electric oven shall be cleaned thoroughly after every use.

1. Cavity of electric oven: clean it with warm water without using any corrosive or abrasive detergent; the stains which are difficult to be removed can be cleaned with a nylon brush or mild detergent rather than a steel wire ball, in order to avoid the surface from being left with un-repairable damages. The detergent to be used in the cavity should be cleaned up and no residue shall be left. After cleaning, wipe cavity out with a piece of wet cloth and keep it dry.

2. Stainless steel decorating plate: wipe it with a piece of soft wet cloth, and clean the oil stains which are difficult to be removed with mild detergent or stainless steel-specific detergent. In this process, please wipe along texture of the steel and dry the plate with a piece of dry cloth after wiping.

3. Glass panel: the glass panel of door and control panel shall be cleaned up immediately after it becomes dirty. The dirt that is difficult to be removed shall be cleaned with mild detergent rather than a steel wire ball, in order to avoid the surface from being scratched. After cleaning, dry it with a piece of cloth.

4. Removal and installation of fan cover plate: the fan cover plate is fixed to the internal cavity with 4 bolts and can be removed by screwing these bolts anticlockwise. Note: the fan cover plate should be reinstalled after being cleaned.

5. Removal and installation of lighting lamp in electric oven: remove the lighting lamp of the electric oven by rotating the glass lamp cover anticlockwise and then pull out the bulb; inset the bulb upward and rotate the glass lamp cover clockwise so that the lighting lamp of the electric oven is reinstalled.

6. In order to make it convenient for cleaning the top of the cavity, you can flip the upper heating tube down. First, rotate the fixation column of heating tube for 90 degrees (as shown in Fig.1), at this moment, the fixed plate at front end of heating tube will separate from the fixation column and then the heating tube can be flipped down about 20 degrees (as shown in Fig.2). Then retighten the upper heating tube in opposite direction, and reinstall the fixed plate of upper heating tube to the fixation column, then rotate it for 90 degrees.

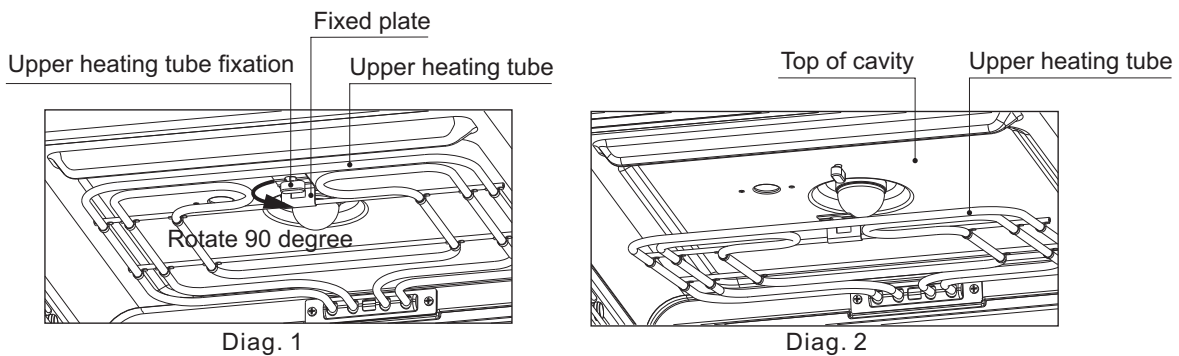

7. Removal and installation of shelves (the procedures for left shelf are the same with that of the right one): press the position of shelf 1 (as shown in Diag.3) until the shelf is disconnected from the positioning bolts, then tilt it to a certain angle and take it out along the direction of arrow as shown in Diag.4, then the shelf can be removed. When reinstalling the shelf, align lower end of the shelf with hole 1 and 2 as shown in Diag.4 and insert the shelf into the hole, then secure the upper end of the shelf with positioning bolts.

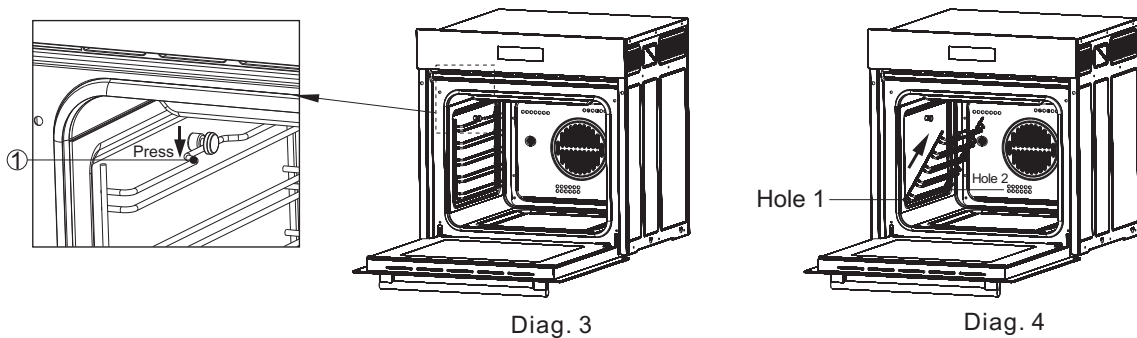

Electrical Schematic Diagram

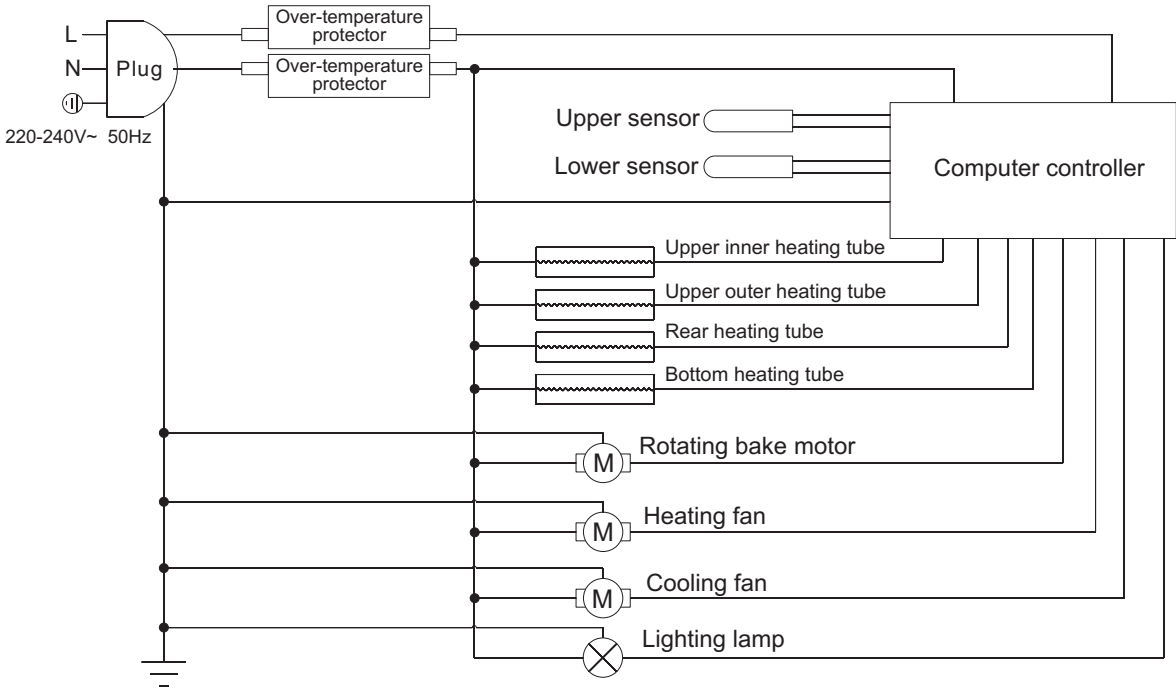

Special statements

Technical improvements of the product (if any) will be incorporated in the Operation Manual of a new version without notice. If any alteration occurs on appearance or color of the product, the actual specifications are subject to the physical product.

Edition: A/1
Publication Date: March,01,2017

ROBAM